



Chemtrol PC Manual 2020

June 2020

Version 2.01

*Santa Barbara Control Systems
5375 Overpass Road, Santa Barbara, CA 93111
Tel: (805) 683-8833 (800)621-2279*

*Fax: (805) 683-1893
Visit at www.sbcontrol.com*

IMPORTANT SAFETY INSTRUCTIONS

Specified by ITS Testing Services for Swimming Pools and Spas

1. READ AND FOLLOW ALL INSTRUCTIONS

2. **WARNING** - To reduce the risk of injury, do not permit children to use this product unless they are closely supervised at all times.
3. A wire connector is provided on this unit to connect a minimum No. 8 AWG solid copper conductor between this unit and any metal equipment, metal enclosures or electrical equipment, metal water pipe or conduit within 5 feet of this unit.
4. **DANGER** - Risk of injury.
 - a) Replace damaged cord immediately.
 - b) Do not bury cord.
 - c) Connect to a grounded, grounding type receptacle only.
5. **WARNING** - This product must be connected to a power source equipped with a ground-fault circuit interrupter (GFCI). The GFCI must be tested before each use. With the product operating, open the service door. If the product stops operating, this merely indicates that the door is equipped with an electrical interlock. Next, push the test button on the GFCI and close the service door. The product should not operate. Now open the service door, push the reset button on the GFCI and close the service door. The product should now operate normally. If the product fails to operate in this manner, there is a ground current flowing indicating the possibility of an electric shock. Disconnect the power until the fault has been identified and corrected.
6. **DANGER** - Risk of electric shock. Install at least 5 feet (1.5 m) from inside wall of tub or spa using nonmetallic plumbing.
7. **DANGER** - Risk of electric shock. Do not permit any electric appliance, such as a light, telephone, radio, or television, within 5 feet (1.5 m) of a spa or hot tub.
8. **WARNING** - To reduce the risk of injury:
 - a) The water in a spa should never exceed 40 °C (104 °F). Water temperatures between 38 °C (100 °F) and 40 °C (104 °F) are considered safe for a healthy adult. Lower water temperatures are recommended for young children and when spa use exceeds 10 minutes.
 - b) Since excessive water temperatures have a high potential for causing fetal damage during early months of pregnancy, pregnant or possibly pregnant women should limit spa water temperatures to 38 °C (100 °F).
 - c) Before entering a spa or hot tub, the user should measure the water temperature with an accurate thermometer since the tolerance of water temperature-regulating devices varies.
 - d) The use of alcohol, drugs or medication before or during spa or hot tub use may lead to unconsciousness with the possibility of drowning.
 - e) Persons suffering from obesity or with a medical history of heart disease, low or high blood pressure, circulatory system problems or diabetes should consult a physician before using a spa.
 - f) Persons using medication should consult a physician before using a spa or hot tub since some medication may induce drowsiness while other medications may affect heart rate, blood pressures and circulation.

9. SAVE THESE INSTRUCTIONS





Copyright © Santa Barbara Control Systems, Inc, all rights reserved.

Information in this publication supersedes that in all previously published material. Specifications and price change privileges reserved.

Printed in the U.S.A.

Santa Barbara Control Systems is a registered trademark of Santa Barbara Control Systems, Inc

WARRANTY

This CHEMTROL® Controller is warranted by SANTA BARBARA CONTROL SYSTEMS (SBCS) to be free from defects in manufacturing and workmanship for a period of FIVE (5) YEARS from the date of purchase for the printed circuit boards and ONE (1) YEAR for all other components. SBCS will repair or replace at its option any defective part during the warranty period. Labor, shipping or incidental expenses are specifically excluded from this warranty. For warranty coverage, defective parts should be returned immediately to your CHEMTROL® Dealer or to our factory postpaid with a copy of your purchase receipt and a description of the malfunction.

NEITHER SANTA BARBARA CONTROL SYSTEMS CORPORATION NOR ANY OF ITS EMPLOYEES SHALL BE LIABLE FOR ANY DIRECT, INDIRECT, SPECIAL, INCIDENTAL OR CONSEQUENTIAL DAMAGES ARISING OUT OF THE USE OF ITS INSTRUMENTS AND SOFTWARE EVEN IF SANTA BARBARA CONTROL SYSTEMS CORPORATION HAS BEEN ADVISED IN ADVANCE OF THE POSSIBILITY OF SUCH DAMAGES. SUCH EXCLUDED DAMAGES SHALL INCLUDE, BUT ARE NOT LIMITED TO: COSTS OF REMOVAL AND INSTALLATION, LOSSES SUSTAINED AS THE RESULT OF INJURY TO ANY PERSON, OR DAMAGE TO PROPERTY.



Document Revisions

Date	Version Number	Document Changes
07/13/2017	0.1	Initial Draft CN3022
06/10/20	0.1	Minor updates



Table of Contents

1	Introduction.....	15
1.1	Scope and Purpose.....	15
1.2	Controller Features.....	15
1.3	UNPACKING.....	15
1.4	Technical Support.....	15
1.5	Chemtrol Water Treatment.....	16
1.5.1	Models.....	16
1.5.2	Automated Water Treatment.....	16
1.5.3	Control Functions.....	17
1.5.4	Sanitizer Control.....	18
1.5.5	Free Chlorine.....	18
1.5.6	Oxidation-Reduction Potential (ORP).....	19
1.5.7	Interaction of pH, ORP, and Free Chlorine.....	20
1.5.8	Free Chlorine control.....	21
1.5.9	Oxidation-Reduction Potential (ORP) Control.....	22
1.5.10	Probe Failure Analysis.....	22
1.6	Legal Requirements.....	23
1.7	Recommendations.....	24
1.8	Background.....	26
1.8.1	Bromine.....	26
1.8.2	Ultra-Violet light.....	27
1.8.3	Cyanuric Acid.....	27
1.8.4	Muriatic Acid.....	28
1.8.5	CO ₂	28
1.8.6	Oxidation-Reduction Potential.....	28
1.8.7	Total Dissolved Solids.....	29
1.8.8	Total Alkalinity.....	30
1.8.9	Shock Treatment.....	30



2	Installation.....	32
2.1	.. <i>Siting (Location)</i>	32
2.1.1	General Layout.....	32
2.1.2	Electrical Codes.....	36
2.1.3	Grounding (GFI).....	36
2.1.4	Electrical Interference.....	36
2.1.5	Main Power Interlock.....	37
2.1.6	Panel Interlock.....	37
2.2	.. <i>SAFETY NOTICE</i>	37
2.3	.. <i>Power Connection</i>	37
2.3.1	Line Voltage.....	37
2.3.2	Line Power Connection.....	37
2.3.3	Line Fuse Replacement.....	38
2.4	.. <i>Installation Report</i>	38
2.5	.. <i>Principles of Operation</i>	38
2.6	.. <i>PC 2100 CPU Boards</i>	39
2.6.1	Display Brightness.....	41
2.6.2	Backup Battery.....	41
2.7	.. <i>PC 604 Series Controllers (3000, 4000, 5000, 5100, 6000, 7100)</i>	42
2.7.1	Display Brightness.....	43
2.7.2	Backup Battery.....	43
2.8	.. <i>CH 2100 Power Supply Board</i>	44
2.8.1	115V/230V Power Transformer.....	45
2.8.2	Relays and Fuses.....	47
2.8.3	Remote Alarm.....	49
2.8.4	Sensor Connections.....	49
2.8.5	Beepers.....	50
2.9	.. <i>Piggy Back Boards</i>	51
2.10	.. <i>Communications Adapters</i>	55
2.10.1	RS-232 Adapter.....	55
2.10.2	RS-485 Adapter.....	55
2.10.3	WiFi Adapter.....	56



2.10.4	Processor Adapter.....	56
2.11.	<i>Sensor Installation.....</i>	57
2.11.1	Plumbing.....	57
2.11.2	Installation of Sensors.....	57
2.11.3	In-line Installation (2" Pipe).....	57
2.11.4	Flow Cell Assembly.....	58
2.11.5	Sensor Cell Cabinet (Option).....	59
2.12.	<i>PPM Sensors.....</i>	60
2.12.1	PPM Sensor Flow Cell.....	62
2.12.2	PPM Sensor Installation.....	63
2.13.	<i>ORP and pH Sensors.....</i>	64
2.13.1	Packaging.....	65
2.13.2	Sensor cables.....	65
2.13.3	Electrical Interference.....	66
2.13.4	Storage and Winterizing.....	67
2.13.5	Sensor Warranties.....	67
2.14.	<i>Temperature Sensor.....</i>	68
2.15.	<i>Conductivity Sensor.....</i>	69
2.16.	<i>Water Flow Sensors.....</i>	70
2.16.1	Magnetic Flow Sensor.....	70
2.16.2	Paddle Wheel Rotary Flow Switch.....	72
2.16.3	Flow Sensor Location.....	72
2.16.4	Flow Sensor Connections.....	73
2.17.	<i>Pressure Transducers.....</i>	75
2.18.	<i>Level Sensors.....</i>	75
2.18.1	Ultrasonic Level Sensors.....	75
2.18.2	Optical Level Sensor.....	82
3	 Chemical Feeders.....	84
3.1...	<i>WARNING: Tank Sizing.....</i>	84
3.2...	<i>Chemical Feed Pumps.....</i>	84
3.2.1	Carbonic Acid (CO ₂) Valve.....	84
3.2.2	Gas Chlorinator.....	84



3.2.3	Erosion Feeders.....	85
3.3	<i>Filter Backwash</i>	86
3.3.1	Main Pump Shutoff.....	86
3.3.2	Single Filter Backwash.....	86
3.3.3	Multiple Filter Backwash.....	87
3.3.4	Backwash Stager.....	87
4	Electrical Valves.....	88
4.1	<i>Solenoid Valves</i>	88
4.2	<i>Hydraulic Valves</i>	88
4.3	<i>Pneumatic Valves</i>	88
5	Controller Operation.....	89
5.1	<i>Control Panel</i>	89
5.2	<i>Welcome Screen</i>	90
5.3	<i>Main Display Readings</i>	90
5.4	<i>Default Setup</i>	92
5.5	<i>Configuration Main Menu</i>	93
5.6	<i>Initial Setup</i>	94
5.6.1	Measurement Units.....	95
5.6.2	Code Numbers.....	95
5.6.3	Clock Setup.....	96
5.6.4	Readings Setup.....	96
5.6.5	Data Logging.....	96
5.6.6	Model Options.....	97
5.7	<i>Operations Menu</i>	98
5.7.1	Bypass Line Submenu.....	98
5.7.2	Saturation Menu.....	99
5.7.3	Print Reports.....	101
5.7.4	Reset Menu.....	101
5.7.5	Battery.....	102
5.7.6	Probe Monitor.....	102
5.8	<i>Communications Menu</i>	103



5.8.1 Network Setup..... 104

5.9... *ORP Menu*..... 106

5.9.1 Calibrate..... 106

5.9.2 Time Limit..... 106

5.9.3 Run Time..... 107

5.9.4 Total Time Alarm..... 107

5.10. *SANITIZER MENU OPTION*..... 108

5.11. *ppmT Menu*..... 110

5.12. *ppmA Menu*..... 111

5.13. *pH MENU*..... 112

5.14. *TDS / Conductivity Menu (Total Dissolved Solids / Conductivity)*..... 113

5.15. *TEMPERATURE CONTROL*..... 115

5.16. *Pump Menu*..... 116

5.17. *Backwash Auto Menu*..... 117

5.18. *PROPORTIONAL CONTROL*..... 118

5.19. *CALIBRATION*..... 119

5.19.1 One-Point Calibration..... 119

5.19.2 Two-Point Calibration..... 119

5.19.3 Three-Point Calibration..... 119

Glossary..... 120

6 STARTUP..... 121

6.1... *Controller Startup*..... 121

6.1.1 Configuration Menu..... 121

6.1.2 Alarm Buzzer..... 121

6.1.3 Bypass Line..... 121

6.1.4 Battery Check..... 121

6.1.5 PPM Board Initialization..... 121

6.2... *Chemical Control*..... 121

6.2.1 Initial Activation of Sensors..... 121

6.2.2 Bypass Line Test..... 122

6.2.3 Water Chemistry Adjustment..... 122



Chemtrol PC Manual 2020

6.2.4	Water Sampling.....	122
6.2.5	pH Calibration.....	122
6.2.6	ORP Setpoint.....	124
6.2.7	Sanitizer Calibration.....	124
6.2.8	Time Limits.....	124
6.2.9	Shock Treatment.....	125
6.2.10	Chemical Saver.....	125
6.2.11	Water Saturation.....	125
7	CHAPTER VI - MAINTENANCE.....	126
7.1	<i>CONTROLLER MAINTENANCE</i>	126
7.1.1	Regular Maintenance.....	126
7.2	<i>The Acid Test</i>	126
7.2.1	Sensor Cleaning.....	126
7.2.2	Sensor Winterizing.....	127
7.2.3	Battery Replacement.....	127
7.2.4	Software Upgrade.....	127
7.3	<i>Final Review and Recommendations</i>	128
7.3.1	pH Control.....	128
7.3.2	ORP and Sanitizer Control.....	129
7.3.3	Limit Timers (Overfeed Safety).....	130
7.3.4	Timer Settings.....	131
7.4	<i>PERIODIC MAINTENANCE</i>	132
7.4.1	Water Testing.....	132
7.4.2	Shock Treatment.....	132
7.4.3	Precautions.....	133
8	TROUBLESHOOTING.....	134
9.1	<i>PARTS, ACCESSORIES AND UPGRADES</i>	137
10	Additional References.....	140
10.1	<i>Crypto</i>	140



Table of Figures

Figure 1 Chemtrol® Family..... 16

Figure 2 Equilibrium of Free Chlorine..... 18

Figure 3 ORP vs Kill Time of E. Coli..... 20

Figure 4. Free Chlorine..... 21

Figure 5. Estimated Time To Kill Bacteria..... 28

Figure 6. Pressure to Vacuum Bypass Line..... 33

Figure 7. Pressure to Atmosphere Bypass Line..... 34

Figure 8. Pressure to Pressure Bypass Line..... 35

Figure 9. CH 2100 Main Board..... 40

Figure 10. CH 2100 Main Board with Display (back)..... 40

Figure 11. PC 604 CPU Board..... 42

Figure 12. PC 604 CPU Board with Display (back)..... 43

Figure 13. CH2100 Power Supply..... 44

Figure 14. CH2100 Power Board..... 45

Figure 15. Voltage Selector Jumpers set to 115 volts (2 jumpers)..... 46

Figure 16. Voltage Selector Jumper set to 230 volts (1 jumper in center) 110v both (2) jumpers cover 4-pins..... 46

Figure 17. Typical Relay..... 48

Figure 18. Sensor Connections on Power Board..... 49

Figure 19. 4-20 mA 4-in 4-out..... 51

Figure 20. 4-20 mA 8-in 8 out Base..... 52

Figure 21. 4-20 mA 8-in 8 out Top..... 52

Figure 22. 4-20 mA ppm Module..... 53

Figure 23. Backwash Relay Expander..... 53



Figure 24. Backwash Relay Expander for PC 6000.....	54
Figure 25. RS-232 Adapter.....	55
Figure 26. RS 485 Adapter.....	55
Figure 27. WiFi Adapter.....	56
Figure 28. Protoessor Adapter.....	56
Figure 29. Sensor Installation.....	58
Figure 30. Flow cell Assembly.....	59
Figure 31. Sensor Cell Cabinet (Option).....	59
Figure 32. PPM Sensor.....	60
Figure 33. PPM Sensor and Mount.....	61
Figure 34. PPM Sensor Flow Cell.....	62
Figure 35. PPM Sensor Package.....	63
Figure 36. ORP Sensor.....	65
Figure 37. pH Sensor.....	65
Figure 38. Temperature Sensor.....	68
Figure 39. Combination Conductivity-Temperature Sensor.....	69
Figure 40. Sensor Model P, P1, and P2.....	70
Figure 41. Magnetic Flow Sensor.....	71
Figure 42. Flow Sensor.....	72
Figure 43. Flow Sensor Location.....	73
Figure 44. Connections to PC2100 (Power supply board).....	73
Figure 45. 4-20 mA Flow Meter Connections to PC 3000, PC 5000, pc 5100, PC6000, pc7000and PC 7100.....	74
Figure 46. Pressure Transducer.....	75
Figure 47. Ultrasonic Level Sensor.....	76



Figure 48. DL-10 Wiring.....	76
Figure 49. DL24 Wiring.....	77
Figure 50. Optical Level Sensor.....	82
Figure 51. Optical Beam Path.....	82
Figure 52. Water Level Assembly.....	83
Figure 53. Level Switch inputs (PC 3000 and above).....	83
Figure 54. Erosion Feeder Control.....	85
Figure 55. Single Filter Backwash.....	86
Figure 56. Multiple Filter Backwash.....	87
Figure 57. Key Pad.....	89
Figure 58. Welcome Screen (Typical).....	90
Figure 59. Main Screen.....	90
Figure 60. Typical Main Menu for PC 2100 series controllers.....	93
Figure 61. Configuration Menu.....	93
Figure 62. Initial Setup.....	94
Figure 63. Bypass Menu.....	98
Figure 64. ORP Total Time Alarm.....	107
Figure 65. TDS Menu.....	113
Figure 66. Proportional Feed Rate.....	118



Table of Tables

Table 1. State of California 22CCR § 65529 Requirements..... 23

Table 2. State of California 22CCR § 65530 Requirements..... 23

Table 3 APSP Recommendations..... 24

Table 4. Model Aquatic Health Recommendations..... 25

Table 5 Internal Wiring..... 36

Table 6. Jumper Configuration..... 48

Table 7. Unit Equivalencies..... 95

Table 8. Corrosion / Scaling Limits..... 100



1 Introduction

CHEMTROL® Automation uses advanced electronic sensing technology to monitor and control the most control critical parameters in water, such as sanitizer activity, pH, temperature, conductivity or total dissolved solids (TDS). These are all essential to maintaining safe and enjoyable water.

1.1 Scope and Purpose

This document covers the application, installation, operation, and maintenance of the Chemtrol® line of water system controllers. These controllers use advanced electronic sensing technology to monitor and control critical parameters in water, such as pH, sanitizer concentration, temperature, conductivity and total dissolved solids (TDS) plus flow pressures. These are all essential to maintaining safe and enjoyable water.

1.2 Controller Features

The CHEMTROL® PC Controllers are microprocessor-based programmable controllers designed for automatic control of water chemistry, water balance and filtration in swimming pools, spas, cooling towers and industrial applications.

1.3 UNPACKING

Be sure not to lose any of the smaller parts, such as PVC fittings.

The controller carton should include the following:

- Controller Cabinet
- Sensors as required for selected model
- Instruction Manual and Warranty Card
- Installation Report to be mailed back to factory upon completion of installation
- Paddle-wheel flow switch
- Bypass Line Assembly (Optional)

1.4 Technical Support

Please take the time to read this detailed Instruction Manual to insure proper installation and operation. If you need further technical assistance, you can contact your Qualified CHEMTROL® Representative, call our Technical Department toll free at 800-621-2279 or e-mail us at chemtrol@sbcontrol.com.



1.5 Chemtrol Water Treatment

1.5.1 Models

This manual covers *CHEMTROL*® models 250, 2100, 3000, 4000, 5000, 5100, 6000, 7000 and 7100 series controllers.



Chemtrol PC-3000



Figure 1 Chemtrol® Family

1.5.2 Automated Water Treatment



The *CHEMTROL*[®] PC controllers are advanced automation systems for water maintenance. Designed around a sophisticated microprocessor, the controllers display user-friendly menus and submenus on an easy-to-read LCD (Liquid Crystal Display) screen. All the displays and adjustments are accessible from menu screens that are laid out in a logical and intuitive order. They can in fact be used without reference to the instruction manual.

All sensing devices are connected to the central control module. That makes it possible to monitor the status of all operational parameters at a glance. Also, in case of malfunction or alarm, the operator is immediately alerted.

1.5.3 Control Functions

The following display and control functions are:

- **Oxidation-Reduction Potential (ORP or Redox)** in millivolts with programmable oxidizer feed, super-oxidation and chemical savings program
- **Sanitizer Concentration** in parts per million (ppm) or milligrams per liter (mg/l) with programmable sanitizer feed, super-chlorination and chemical savings program
- **pH** from 6.00 to 9.00 with capability for acid and base feed (0 to 14.00 available)
- **Conductivity** in microsiemens/cm or **Total Dissolved Solids (TDS)** in ppm or mg/l with capability for programmed dumping and replacement of water and for addition of three different chemical additives, such as inhibitor, different biocides or probe cleaner
- **Pump Control** Water recirculation and filtration pumps. VFD (Variable Frequency Pumps) are supported.
- **Heater Control** with temperature display in degrees Fahrenheit or Celsius and programmable heater control and energy savings program are supported.
- **Water Recirculation** with automatic programming or manual control of main pump plus display of flow rate in gallons per minute (gpm) or liters per minute (l/m) and cumulative flow in Millions of Gallons (Mga) or cubic meters (m³)
- **Water Balance** and **Saturation Condition** derived from the **Langelier Saturation Index** and showing water balance conditions as either OK, corrosive or scaling



- **Filtration** with display of influent and effluent pressure and programmable filter backwashing based on choice of time, inlet pressure, pressure differential or combinations of the above
- A 24-hour clock/calendar shows the date and time on the main screen. For models that do not include all the functions listed above, only the applicable screens and menus are shown.

1.5.4 Sanitizer Control

The CHEMTROL® PC controllers offer several choices for sanitizer control:

- Direct chlorine control using a solid state sensor with selective membranes for free chlorine and total chlorine
- Oxidation-Reduction Potential control for chlorine or bromine using an ORP sensor with a platinum ring or gold ring (available on all PC controllers).
- Ozone or any other non-chlorine oxidizer.

1.5.5 Free Chlorine

When chlorine in any form is introduced in water it dissociates to form hypochlorous acid HOCl, and OCl⁻ ions. Hypochlorous acid, HOCl, is a weak acid and it in turn, dissociates to produce a pH driven balance between hypochlorite ions OCl⁻ and a hydrogen ions H⁺.

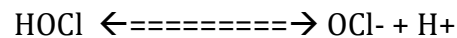

Free chlorine in water is therefore always present in two forms: hypochlorous acid and HOCl ions. The percentage of each is highly dependent upon pH as shown.



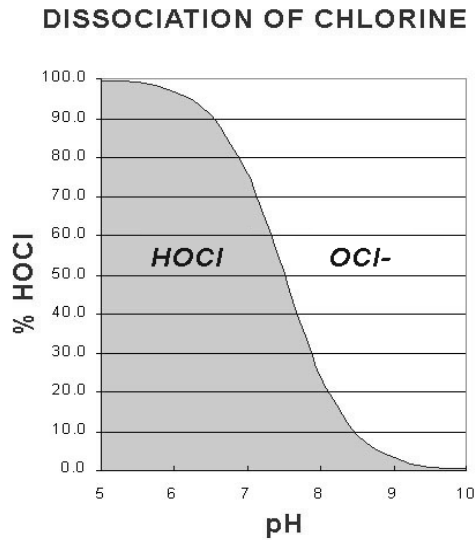

Figure 2 Equilibrium of Free Chlorine.

Hypochlorous acid HOCl is an effective and a fast acting sanitizer. On the other hand, hypochlorite ions OCl⁻ are a much slower acting sanitizer. HOCl is 80 to 300 times more effective than OCl⁻ ions and the concentration of HOCl decreases rapidly with increasing pH. Thus it is important to keep the pH within the acceptable range of 7.2 to 7.6. Ideally, the pH should be 7.5.

The precise reaction depends upon temperature, presence of other acids (typically cyanuric) and water pH.

1.5.6 Oxidation-Reduction Potential (ORP)

The oxidizing activity of the sanitizer (chlorine or bromine) can be monitored with a special electrode for Oxidation-Reduction Potential, called ORP or Redox.

ORP does not measure sanitizer concentration but rather the activity of the sanitizer present (HOCl or HOBr). ORP readings provide an excellent index of bacteriological water quality. Ideally, ORP should be kept at a minimum of 700 mV to ensure an efficient kill-time.



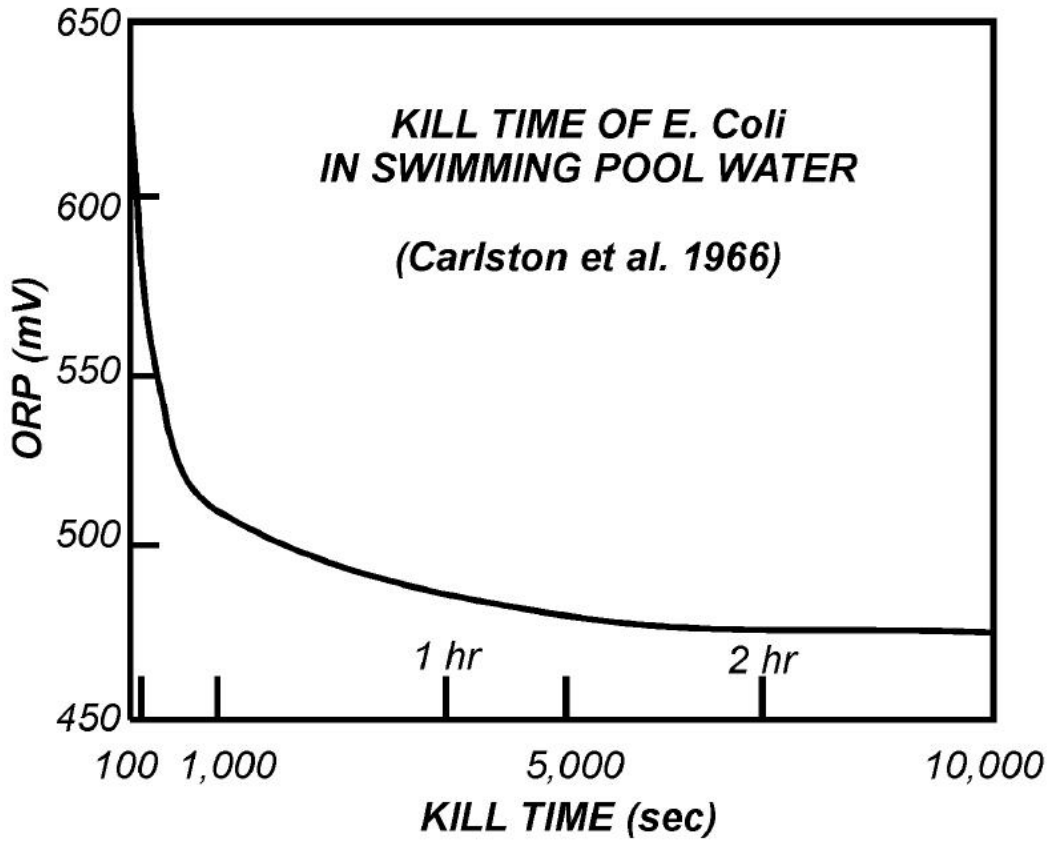

Figure 3 ORP vs Kill Time of E. Coli

1.5.7 Interaction of pH, ORP, and Free Chlorine

The pH, ORP, and Free Chlorine all interact thus it is important to accurately measure and feed corrective chemicals as early as possible. The targets are

- pH between 7.4 and 7.6,
- a minimum Free Chlorine level of 1.0 ppm (mg/l) to 3 ppm ,
- an Oxidation-Reduction Potential (ORP) above 650 mV,



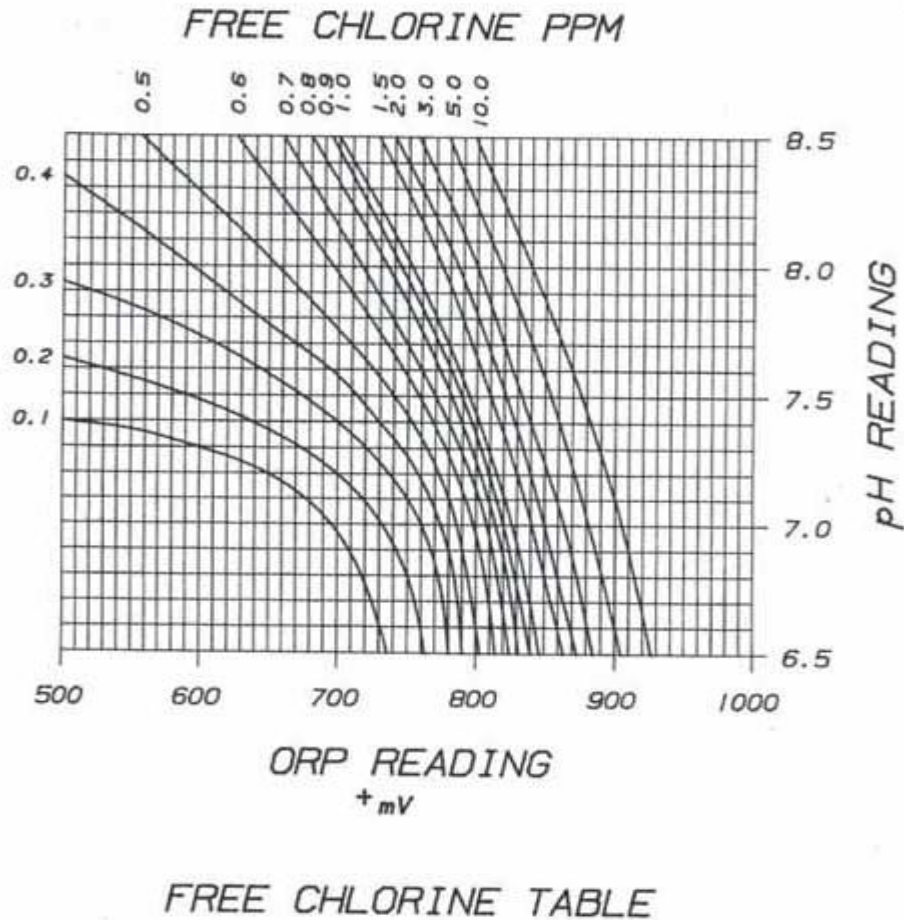

Figure 4. Free Chlorine

1.5.8 Free Chlorine control

The CHEMTROL® includes true Free Chlorine control using a solid state sensor with a selective membrane for Free Chlorine. Bromine can also be displayed if the proper sensor is specified.

The controller displays the concentration of Total Free Chlorine (HOCl + OCl-) in PPM (parts per million or milligrams/liter). It does not respond to Bromine and is not affected by oxidizers.

The Free Chlorine display does not vary with pH.

The PPM set point default value on the controller is 1.0 ppm, which is recommended to kill microorganisms and bacteria and maintain good water quality. It can be adjusted to meet local conditions and Health Department requirements.



1.5.9 Oxidation-Reduction Potential (ORP) Control

In 1971, the third edition of the "International Standards for Drinking Water Quality" of the **WORLD HEALTH ORGANIZATION (WHO)** stated:

"A redox potential of 650 mV (measured between platinum and calomel electrodes) will cause almost instantaneous inactivation of even high concentrations of virus. Such a potential can be obtained with even a low concentration of free chlorine but only with an extremely high concentration of combined chlorine."

In 1985, a study of thirty commercial spas by the **OREGON DEPARTMENT OF HEALTH** also confirmed 650 mV to be the minimum value required to prevent growth of germs and bacteria. Public pools and spas in many European countries are required by law to maintain an ORP level of 750 mV or more.

The use of ORP testing does not eliminate the need for testing the sanitizer level with standard test kits.

1.5.10 Probe Failure Analysis

All **CHEMTROL®** PC controllers include the exclusive safety feature called Probe Failure Analysis.

With this proprietary technology (US Patent No. 5,895,565), the controller continuously monitors and tests the dynamic response of the ORP and pH sensors. This important feature allows early detection of probe failure, thereby avoiding the dangerous out-of-range conditions that can develop with other controllers.



1.6 Legal Requirements

The minimum requirements for safe water are usually set by state and local regulations. In addition, pool equipment must be protected from aggressiveness of water and its constituents.

As an example, the State of California 22 CCR § 65529 requires pool water to be maintained within the limits shown in Table 1.

	Free-Chlorine Residual				Bromine Residual	
	Without CYA		With CYA		Min	Max
	Min	Max	Min	Max		
Public Pools*	1.0 ppm	10.0 ppm	2.0 ppm	10.0 ppm	2.0 ppm	--
Public Spas, Wading Pools, and Spray Grounds	3.0 ppm	10.0 ppm	3.0 ppm	10.0 ppm	4.0 ppm	--

CYA = cyanuric acid; Min = minimum; Max = maximum; ppm = parts per million.

*This includes all public pools except spas, wading pools, and spray grounds.

Table 1. State of California 22CCR § 65529 Requirements

Section 22CCR § 65530 requirements are shown in Table 2.

	Minimum	Maximum
pH	7.2	7.8
Cyanuric Acid Concentration	0.0 ppm	100.0 ppm
Pool Water Temperature	Not applicable	104° F

ppm = parts per million.

Table 2. State of California 22CCR § 65530 Requirements

In addition, Section 22 CCR § 65527 requires that the bottom of the pool be “clearly visible”. Section 22CCR § 65523 requires pool operators to measure and record the pH, disinfectant residual, and temperature daily.



1.7 Recommendations

The Association of Pool & Spa Professionals (successor to the National Spa and Pool Institute) recommendations are shown below

Table 3 APSP Recommendations

TEST	MIN	IDEAL	MAX
pH	7.2	7.5	7.6
FREE CL, ppm	1	1.5	2
Non-stabilized	1.5	2	3
Spa	2	3	5
COMBINED CL, ppm	0	0	0.2
BROMINE, ppm	2	3	4
OZONE, ppm	0.01	-	1
ORP, mV	650	750	-
CYANURIC ACID, ppm Outdoor	30	40	100
TOTAL ALKALINITY, ppm	100	125	150
TDS, ppm	300	1000	3000
Based on Standards for Public Pools and Spas. Published in 1988 by the NATIONAL SPA AND POOL INSTITUTE			



The 2018 Model Aquatic Health Code, 3rd Edition CODE LANGUAGE (Posted on 07/18/2018) Recommendations are shown below:

Table 4. Model Aquatic Health Recommendations

TEST	MIN	IDEAL	MAX
pH	7.2		7.8
FREE CL, ppm	2.0		10.0
Non-stabilized	1.0		
Spa			
COMBINED CL, ppm			0.4
BROMINE, ppm	3.0		8.0
Spas, ppm			4.0
OZONE, ppm	<0.1		
ORP, mV	600		900
CYANURIC ACID, ppm Outdoor			<= 90
TOTAL ALKALINITY, ppm	60		180
TDS, ppm (test quarterly)			
Based on 2018 MAHC Code (3rd Edition) – 07/18/2018 Center for Disease Control			

Other organizations publish recommendations for maintenance of water quality. Chemtrol recommends the following:

- proper water balance with a pH between 7.4 and 7.6,
- a minimum Free Chlorine level of 1.0 ppm (mg/l) ,
- alkalinity between 80 and 120 ppm (mg/l) and
- an Oxidation-Reduction Potential (ORP) above 650 mV,
- if required, stabilization not exceeding a cyanuric acid level above 40 ppm (mg/l),
- Total Dissolved Solids (TDS) less than 1,500 ppm (mg/l). In pools that utilize electro-chlorination will have a TDS level of 2500 to 3000 ppm.



- Langelier Saturation Index between 0 and 0.3,
- adequate filtration with a minimum turnover rate of six hours for a pool or 30 minutes for a spa.

1.8 Background

The maintenance of safe enjoyable water in a pool or spa depends on a delicate balance of several interacting parameters.

Water that is too acidic is irritating to the skin as well as corrosive to pool equipment. Water that is too alkaline can cause excessive scaling as well as reduce the sanitizer effectiveness.

Hypochlorous acid (HOCl) does the sanitizing work by destroying the cell walls of the microorganisms. This process is called oxidation and is roughly the equivalent of burning. The hypochlorous acid combines with organic nitrogen compounds and becomes chloramines and no longer useful as a sanitizer. There are many methods used to introduce chlorine into pool water.

- sodium hypochlorite (liquid bleach),
- calcium hypochlorite (granular or tablet),
- lithium hypochlorite
- chlorinated isocyanurates.
 - dichloroisocyanurate
 - trichloroisocyanurate
- liquid chlorine
 - Direct injection

When any of these compounds react with water, hypochlorous acid (HOCl), the active sanitizing agent, is released. The chlorinated isocyanurates, also add cyanuric acid or stabilizer. Stabilizers, which can also be added separately, reduce excess loss of free chlorine due to the ultraviolet rays of the sun.

Chlorine itself is highly toxic as well as effective against most pathogens (a notable exception is *Cryptosporidium*). The trend has been away from chlorine gas to materials that are safer and easier to store and will produce an effective level of free chlorine.

1.8.1 Bromine

Bromine is similar to Chlorine but has its own set of advantages and disadvantages.

Bromine Advantages



- Better stability at higher temperatures that would rapidly deplete chlorine
- A Bromine ppm sensor is available.
- More potent at higher pH levels where chlorine becomes ineffective above pH of 7.8
- Bromine can be reactivated by super-chlorinating
- Bromamines are active sanitizers, with low odor whereas chloramines are weak sanitizers and gas-off more readily
- Adds no cyanuric acid or calcium to the water where stabilized chlorine products can add excessive cyanuric acid

Bromine Disadvantages

- Bromine tablets are more expensive than chlorine. Cost can be 2/3 more.
- Bromine is a weaker oxidizer than Chlorine and 2 to 3 times as much Bromine may be required to achieve similar results.
- Bromine is not as widely available as chlorine
- Bromine is not as effectively stabilized from the sun where chlorine can be stabilized with cyanuric acid.

1.8.2 Ultra-Violet light

Ultraviolet sanitizers are often used in combination with chlorine sanitization. The ultraviolet is effective against microorganism and algae that is chlorine resistant. The major disadvantage is that water turbidity (cloudiness) can make the process less effective. In addition, there is no residual treatment for water that does not go through the UV sanitizer.

1.8.3 Cyanuric Acid

Cyanuric acid $(\text{CNOH})_3$ has a complex reaction with water. It forms a weak chemical bond with chlorine, and has the ability to absorb UV light. Cyanuric acid will protect the chlorine until it is consumed for oxidation or disinfection in the pool. Cyanuric acid is often referred to as a stabilizer or conditioner.

A pool with cyanuric acid will remain chlorinated in direct sunlight longer. Without the cyanuric acid, the chlorine would dissipate in a matter of hours. Cyanuric acid is not consumed and will, over time, accumulate in the pool water.

By forming temporary bonds with the free chlorine, cyanuric acid will reduce the overall effectiveness of chlorine and thereby slightly increase the kill time for a given concentration of free chlorine as shown in Figure 5. Estimated Time To Kill Bacteria. pH



and Oxidation Reduction Potential also impact the effectiveness of chlorine so it is important to keep all the factors in balance.

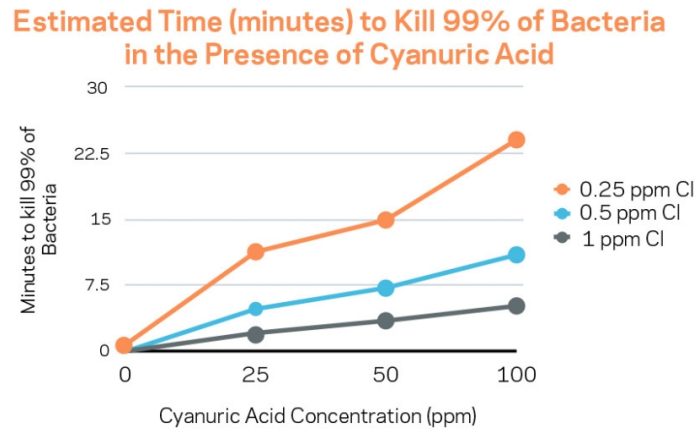

Figure 5. Estimated Time To Kill Bacteria

Data for this chart comes from Anderson, J.R., "A Study of the Influence of Cyanuric Acid on the Bactericidal Effectiveness of Chlorine," American Journal of Public Health, Oct, 1965.

Cyanuric acid cannot be filtered out thus the usual method is to completely drain and refill the pool. Cyanuric acid level can be reduced by partial draining and addition of fresh water or by reverse osmosis treatment.

1.8.4 Muriatic Acid

Muriatic acid or hydrochloric acid (HCl) is a strong acid that completely dissociates in water and is used as an acidifying agent. Upon mixing hydrochloric acid with common oxidizing chemicals, such as sodium hypochlorite (bleach, NaOCl), the toxic gas chlorine is released.

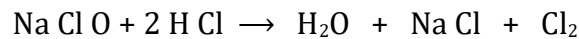

Carlson S (1965) [Modern swimming pool water hygiene.] Schriftenreihe Verein Wasser-,Boden- und Lufthygiene, 27: 27–34 (in German).

1.8.5 CO2

For pools with low alkalinity, CO₂ may be used to lower pH. When CO₂ dissolves in water it forms H₂CO₃ which then dissociates to form a weak acid.

1.8.6 Oxidation-Reduction Potential



In simple terms, oxidation is the gain of electrons and reduction is the loss of electrons. Similarly, an oxidizing agent is a substance that oxidizes something else and a reducing agent is something that reduces something else. Oxidation and reduction are processes that occur simultaneously

In pool chemistry the oxidizing agent is the hypochlorous acid (HOCl) which oxidizes the microorganisms and other contaminants. The strength of the reaction is known as the oxidation-reduction potential (ORP). Thus ORP is a good indicator of the effectiveness of the chlorination.

Oxidation Reduction Potential is measured in mV and the higher the value the stronger the tendency to oxidize and the stronger sanitizing capability. ORP interacts with pH thus it is important to keep the pool in chemical balance.

1.8.7 Total Dissolved Solids

Total Dissolved Solids (or TDS) is the measure of all the inorganic and organic substances dissolved in the water. TDS is determined by measuring the electrical conductivity of the pool water.

Distilled or pure water has a TDS of 0 ppm, drinking water should have a maximum of 500 ppm¹. Communities with hard water can have a TDS of over 700 ppm. Fresh water pools should have a maximum of 2000 ppm. In contrast, sea water is about 35000 ppm. Salt pools may be up to 3000-5000 ppm.

High levels of TDS can result in problems such as:

- cloudy pool water
- staining of the pool surfaces
- hard water and scaling
- salty taste
- algae growth and increased bacteria
- irritated skin & eyes
- accelerated wear on plaster/pebble tech
- inability of chlorine to disinfect
- Needing to run the pump longer in order to combat the above problems

¹ United States Environmental Protection Agency: Drinking Water Standards And Health Advisories Table. Nov 2009.



The only practical way to treat high levels of dissolved solids is to drain the pool, and start over with fresh water. Reverse osmosis treatment will reduce TDS but ordinary filtering is ineffective.

1.8.8 Total Alkalinity

Total alkalinity is a measure of how well the water can “soak up” or neutralize acid. The chemical reaction is complex but the net result is that pool water with low total alkalinity will change pH very rapidly when a small amount of acid is added. Pool water with high total alkalinity is resistant to pH change and can be difficult to adjust. Recommended total alkalinity is 80 to 120 ppm.

Total alkalinity also has its side effects. If the total alkalinity is too high, the pH will be difficult to adjust (constantly adding acid), the water becomes cloudy, and the chlorine loses its efficiency as a disinfectant.

If the total alkalinity is too low plaster walls may erode, metals will corrode, the water may turn green, and the pool can be uncomfortable to use due to a burning sensation. In this case, the pH can also be difficult to adjust as it keeps changing (pH bounce).

Even in a well-maintained pool, total alkalinity changes. Sodium bicarbonate is often used to raise the total alkalinity and addition of acid used to lower total alkalinity.

1.8.9 Shock Treatment

The pool odor is generally due to the presence of chloramines. When chlorine disinfectants are added to water they react with the water and form hypochlorous acid (HOCl) and hypochlorite ions (OCl⁻). The hypochlorous acid oxidizes germs and bacteria.

Hypochlorous acid also reacts with ammonia to form several chloramine compounds: monochloramine, dichloroamine, and trichloroamine (nitrogen trichloride). The ammonia compounds are also introduced into the pool through sweat and urine. The amount of chlorine that is tied up in these chloramines is known as “combined available chlorine” and is unavailable as a disinfectant.

Shock treatment (super chlorination) may be used to destroy the organic contaminants, oxidize the ammonia and chloramines and eliminate the “chlorine” smell. Adding 10 times the level of combined chlorine or chloramines in the water achieves so-called breakpoint chlorination when there is enough extra chlorine to consume the irritating chloramines.

Cryptosporidium parvum, or crypto, is a microorganism that causes gastrointestinal illness, similar to that of *Giardia*. Crypto is usually originates from fecal matter and is spread through swimming pool water. Crypto is tolerant to a wide range of chlorine concentrations and, when a suspected case of crypto occurs, the Centers for Disease



Control and Prevention recommends a free chlorine concentration of 20 ppm for 32 hours to inactivate 99.9 percent of crypto in the pool (CT=15,300 mg*min/L).²

Ultra Violet (UV) disinfection will also help decrease levels of these types of microorganism.

² However, the CDC recommendation does not take into account the level of cyanuric acid usually present in outdoor pools.



2 Installation

2.1 Siting (Location)

Mount the cabinet on a wall in a secure location:

- more than 10' (3 m) away from the water edge to comply with electrical code requirements,
- within 10' (3 m) of the main recirculation line or of the bypass line - unless special extension cables are used for the sensors (see Sensor Cables),
- not exposed to direct sunlight as the LCD display screen will darken at high temperature,
- easily accessible to maintenance personnel,
- if possible in a separate room, or in a well-ventilated room as far away as possible from corrosive chemicals and storage tanks,
- at a safe distance from power transformers, pump motors or high voltage power lines,
- safe from unauthorized access or vandalism

2.1.1 General Layout

There are three basic configurations for the bypass line. The exact configuration used depends upon several considerations determined by each site. The three configurations are:

- Pressure to Vacuum
- Pressure to Atmosphere
- Pressure to Pressure



2.1.1.1 Pressure to Vacuum

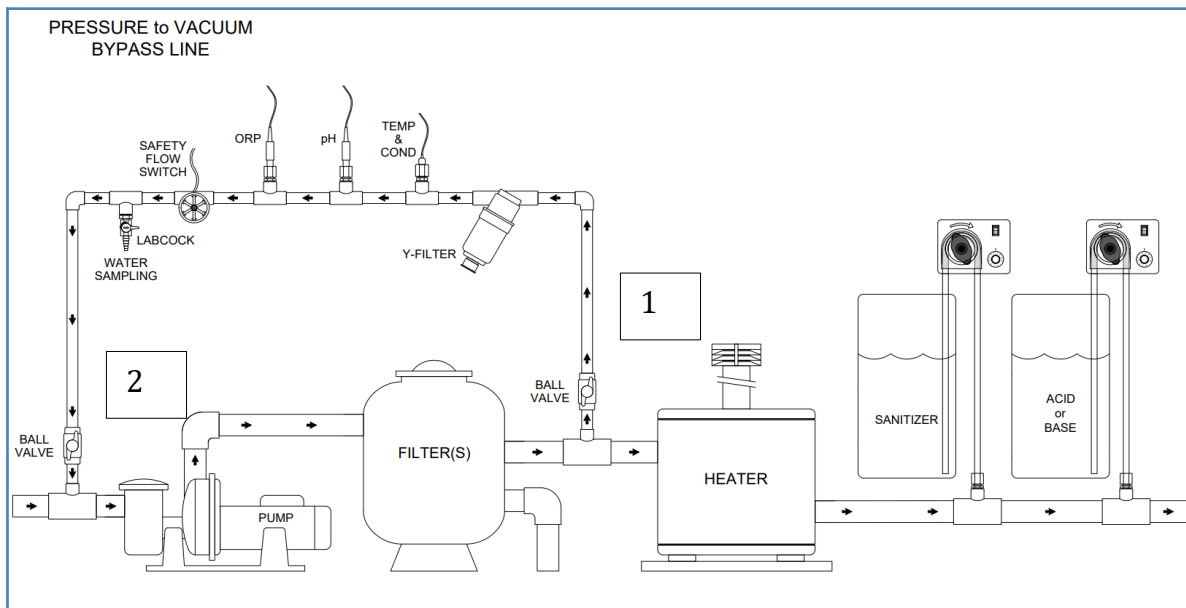

Figure 6. Pressure to Vacuum Bypass Line

In this configuration, the bypass line connects between the output of the filter and the input to the pump. The pressure at the filter (downstream from the pump) is higher than the input side of the pump thus providing the pressure differential necessary to cause flow through the bypass line. It is recommended to provide a self-priming pump.

Procedure to set is to

1. Turn the ball-valve fully on with the inlet open
2. Regulate the flow with the ball-valve on the vacuum side.



2.1.1.2 Pressure to Atmosphere

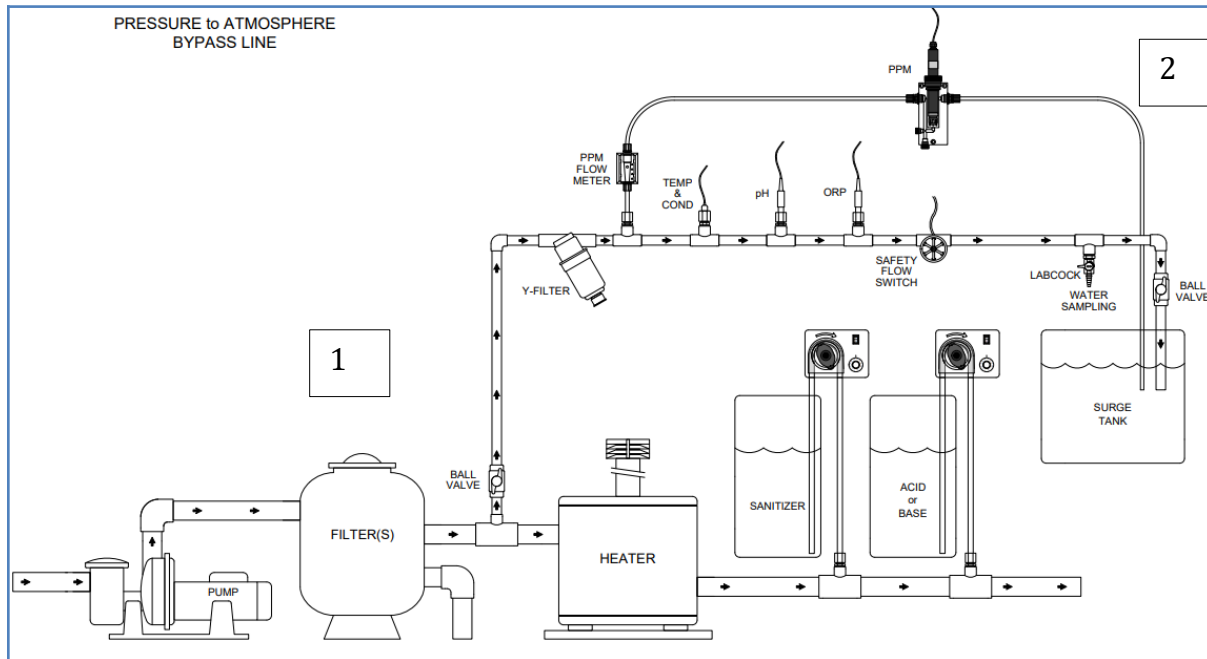

Figure 7. Pressure to Atmosphere Bypass Line

In this configuration, the bypass line connects between the output of the filter and the surge tank. The pressure at the filter (downstream from the pump) is higher than the outside pressure thus providing the pressure differential necessary to cause flow through the bypass line.

Procedure to set is to

1. Turn the ball-valve fully on with the supply side
2. Regulate the flow with the ball-#2,.



2.1.1.3 Pressure to Pressure

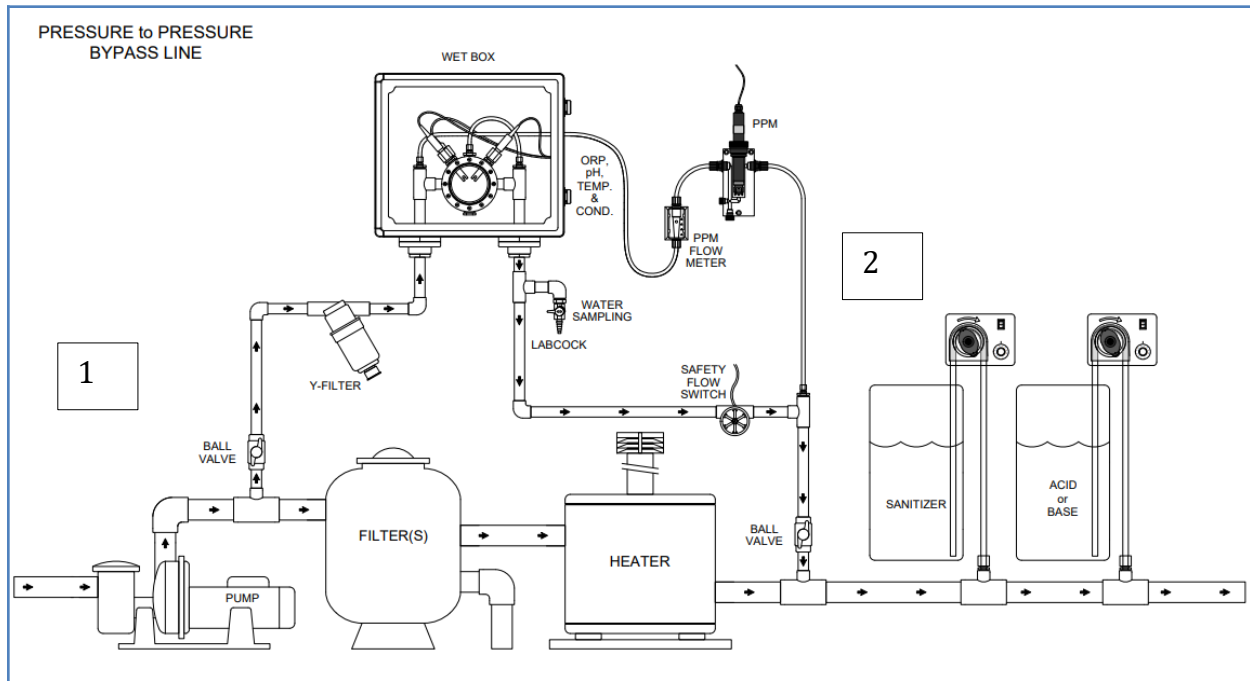

Figure 8. Pressure to Pressure Bypass Line

In this configuration, the bypass line connects between the output of the pump and the output of the heater. The hydrodynamic resistance to the flow through the filter and heater generates a pressure differential that, in turn, causes flow through the bypass line.

Procedure to set is to

1. Turn the ball-valve fully on with the inlet open
2. Regulate the flow with the ball-valve.

This configuration may require more frequent cleaning and/or replacement of sensors.



2.1.2 Electrical Codes

***INSTALLATION MUST FOLLOW
ALL APPLICABLE ELECTRICAL CODES***

The controller is available in either hard-wiring or plug-in configurations. Make sure to use the proper type of wiring according to the local electrical code, usually the same as for the chemical feeders.

The internal wiring and labeling for the Power Board of the controller are as follows:

		RELAYS	POWER IN
GREEN	GROUND	GND	GND
BLACK	HOT	NO1	L1
WHITE	NEUTRAL	NO2	L2

Table 5 Internal Wiring

2.1.3 Grounding (GFI)

A grounding lug is provided on the right side of the cabinet. Connect to an earth ground to reduce shock hazard and eliminate leakage current leakage. Ground Fault Interruption (GFI) protection is strongly recommended for all installations.

2.1.4 Electrical Interference

The *CHEMTROL*® PC controllers feature differential amplification of the sensor signals to reduce electrical interference from stray currents in the water.



To check for current leakage, compare the readings of the sensors when they are in line and when they are dipped in a plastic bucket containing the same water from the pool or spa. Different readings generally indicate current leakage interference. Its source must be identified and eliminated with proper grounding by a qualified electrician.

2.1.5 Main Power Interlock

To prevent accidental chemical feeding, the controller and the chemical feeders should always be interlocked - i.e. wired in parallel - with the manual switch for the main pump. This prevents feeding chemicals when there is no water flow in the recirculation line. Note that the power input should never be used as the primary chemical disable switch.

2.1.6 Panel Interlock

For safety of operation, a panel interlock switch is mounted inside the cabinet to shut off all internal power when the control panel is open. The interlock may be defeated for maintenance purposes by pulling on the plunger.

2.2 SAFETY NOTICE

See important safety information on the first page of the manual.

2.3 Power Connection

2.3.1 Line Voltage

The controller operates from a line voltage in the range of 110V to 240V at a frequency of 50 or 60Hz. Line voltage selection is accomplished by setting jumpers.

CAUTION: Operating the unit on an incorrect line voltage will cause damage and void the warranty.

2.3.2 Line Power Connection

Perform the following steps to connect the controller to line power:

1. Connect the female end of the supplied power cord to a grounded AC receptacle on the rear panel.
2. Connect the other end of the supplied power cord to a grounded AC outlet.



WARNING: The power cord supplied with the controller contains a separate ground for use with grounded outlets. Failure to use a grounded outlet may result in personal injury or death due to electric shock.

2.3.3 Line Fuse Replacement

A rear panel fuse protects the power line input of the controller. If the line fuse needs replacement, perform the steps below:

WARNING: Disconnect the line cord from the unit before changing the line fuse.

1. The fuse is located in a holder in the power module unit above the AC receptacle (figure 3-1).
2. Slide the fuse holder out to gain access to the fuse carrier and fuse.
3. Remove the carrier with the blown fuse, and replace with the correct type listed in Table 3-1.
4. **CAUTION:** For continued protection against fire or unit damage, replace the fuse only with the type and rating listed.
5. Install the fuse carrier in the fuse holder, then insert the fuse holder back in the power entry module.

2.4 Installation Report

The Installation Report is a triplicate form designed to assure warranty coverage, technical updates and factory support.

- 1. White copy: to mail back to factory.
- 2. Yellow copy: to Qualified Dealer.

Upon completion of installation, it must be filled out and signed by the Qualified Dealer and by the facilities manager.

2.5 Principles of Operation

All information provided by the sensors is processed by the microprocessor on the Main Board and displayed on the Main Display screen. Command signals are then sent to the different control outputs on the Power Board.



This manual covers the installation of the PC 2100, PC 3000, PC 4000, PC 5100, PC 6000, PC 7000 and PC 7100 controllers.

PC controller is contained in a rain proof and splash proof NEMA Type 4 cabinet. The cabinet also includes mounting ears for easy installation. Internally, each controller consists of a main processor board, display, keypad and various add-on modules specific to the installation that may be required.

The circuit boards are protected with a 1 A fuse located on the Power board. It is mounted on the lower right of the Power Board and marked F9. If the fuse has to be replaced, make sure to use a 1 A fuse only. The use of a larger fuse may result in irreparable damage to the electronic boards.

2.6 PC 2100 CPU Boards

The key electronic components are the microprocessor and the programmable chips for Program, Display and Memory. All the electronic and electrical components are mounted inside the cabinet on two separate PC Boards: the Main CPU BoardError: Reference source not found and the Power Board.

The Main Board, or mother board, is mounted directly behind the face panel of the controller and contains all the low voltage circuitry including the microprocessor and SD Card, the LCD display and the keyboard pad. It is also used to connect all the sensor inputs.



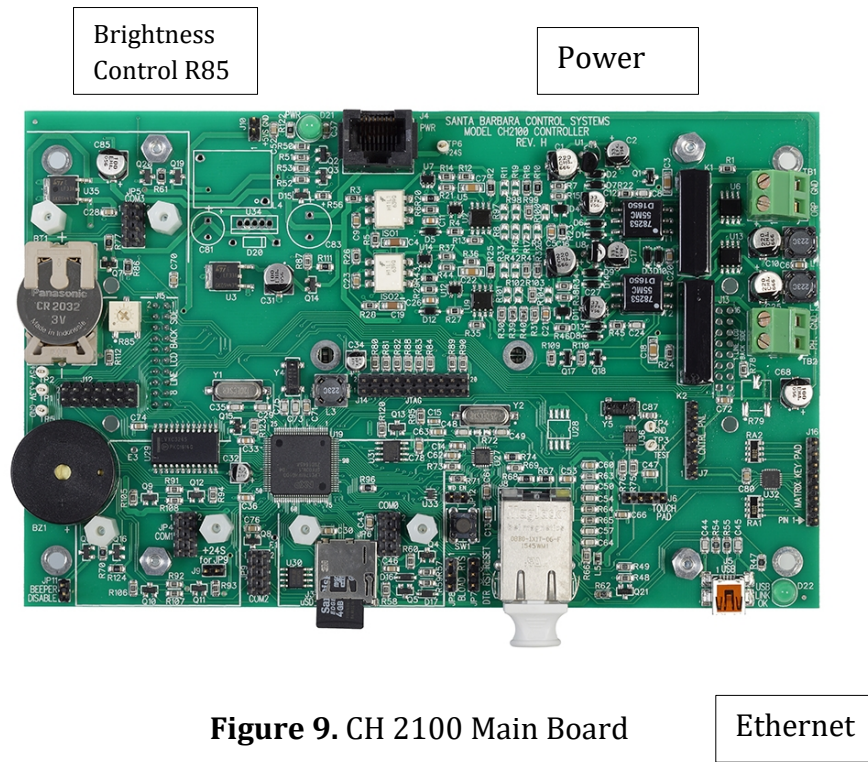

Figure 10. CH 2100 Main Board with Display (back)



2.6.1 Display Brightness

The contrast of the display can be adjusted with the potentiometer marked R85 on the PC2100c that is located on the upper left of the Main Board adjacent to the battery (Figure 10).

2.6.2 Backup Battery

The 3V Backup Battery is located on the left side of the Main Board. It is used to maintain the memory settings in case of loss of AC power. This battery is designed to last for several years in normal operation.

Under normal conditions, the controller will operate without battery power. However, the clock and other memory settings will have to be restored in case of complete power shutdown. Replace the battery if the voltage falls below 2.6 V. The voltage is displayed in Configuration Menu / Battery Submenu.



2.7 PC 604 Series Controllers (3000, 4000, 5000, 5100, 6000, 7100)

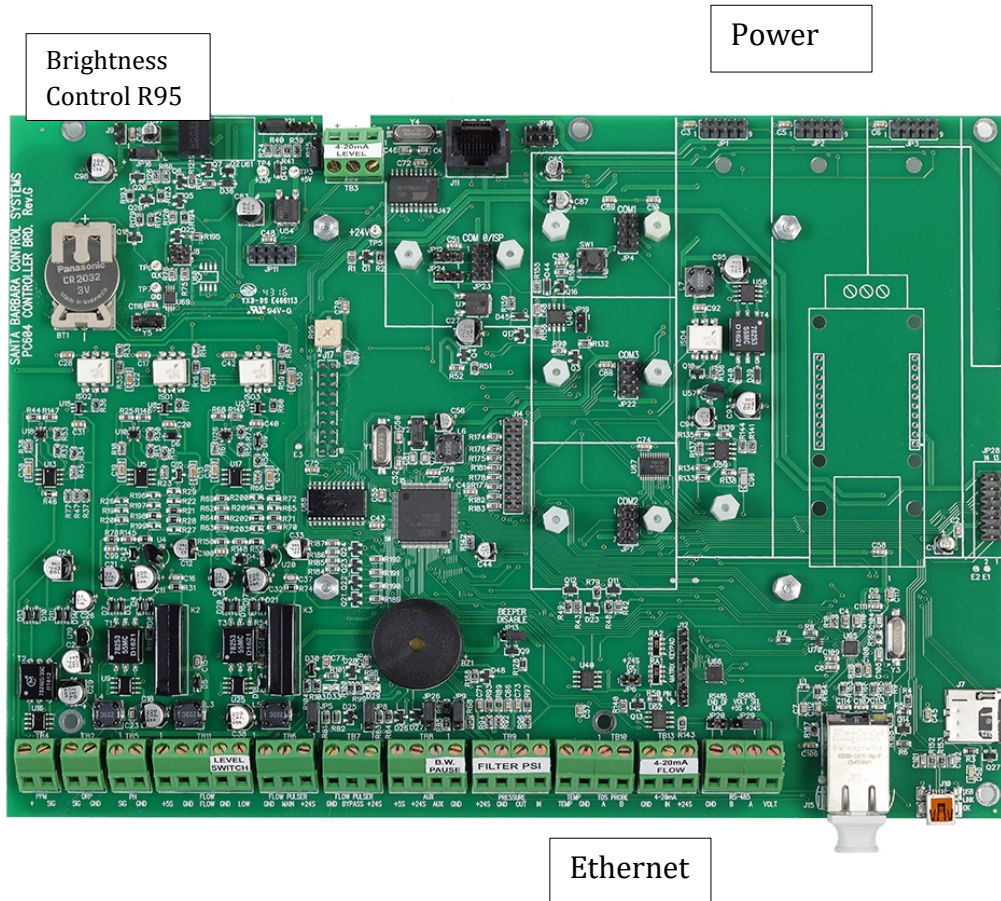

Figure 11. PC 604 CPU Board

Similar to the PC2100, the key electronic components are mounted on the Main Board (mother board). All the electronic and electrical components are mounted inside the cabinet on two separate PC Boards: the Main CPU Board and the Power Board.

The Main Board, or mother board, is mounted directly behind the face panel of the controller and contains all the low voltage circuitry including the microprocessor and program chips, the LCD display and the keyboard pad. It is also used to connect all the sensor inputs.



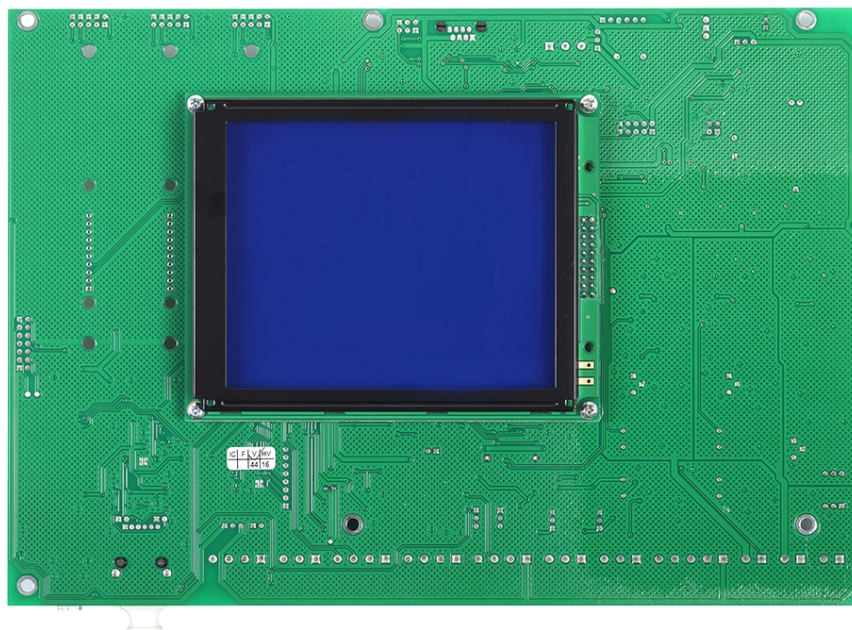

Figure 12. PC 604 CPU Board with Display (back)

2.7.1 Display Brightness

The contrast of the display can be adjusted with the potentiometer marked R95 on the PC604 Board that is located in the mid section of the Main Board.(Figure 11. PC 604 CPU Board)

2.7.2 Backup Battery

The 3V Backup Battery is located on the left side of the Main Board. It is used to maintain the memory settings in case of loss of AC power. This battery is designed to last for several years in normal operation.

Under normal conditions, the controller will operate without battery power. However, the clock and other memory settings will have to be restored in case of complete power shutdown. Replace the battery if the voltage falls below 2.6 V. The voltage is displayed in Configuration Menu / Battery Submenu.



2.8 CH 2100 Power Supply Board

The CH2100 power supply is supplied with one of several options. On each option, the relays are clearly marked for each function. Not all relays may be included on the Power Board, depending on specified options.

Power Out to CPU Board Only
NO ETHERNET CONNECTION

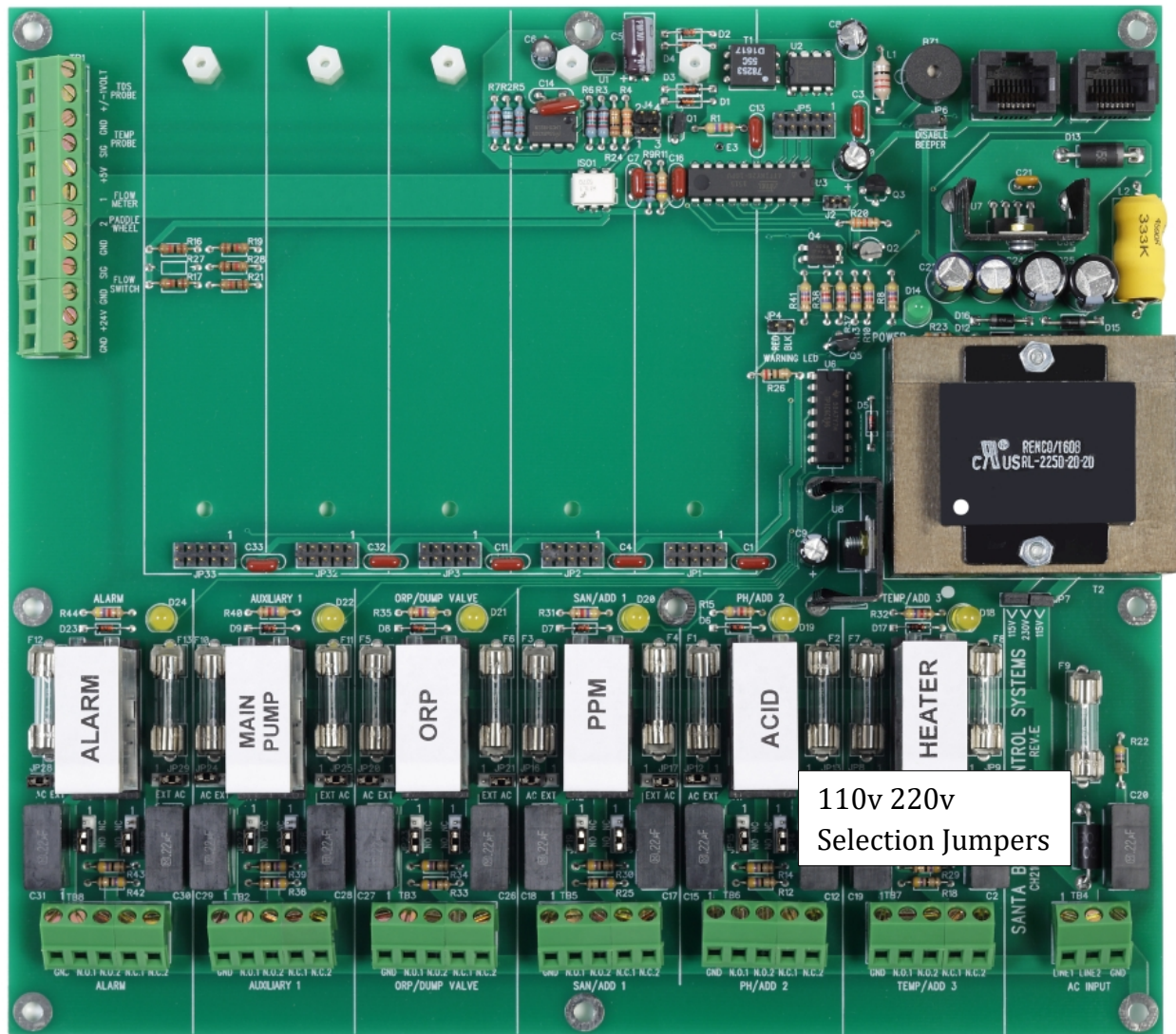

Figure 13. CH2100 Power Supply



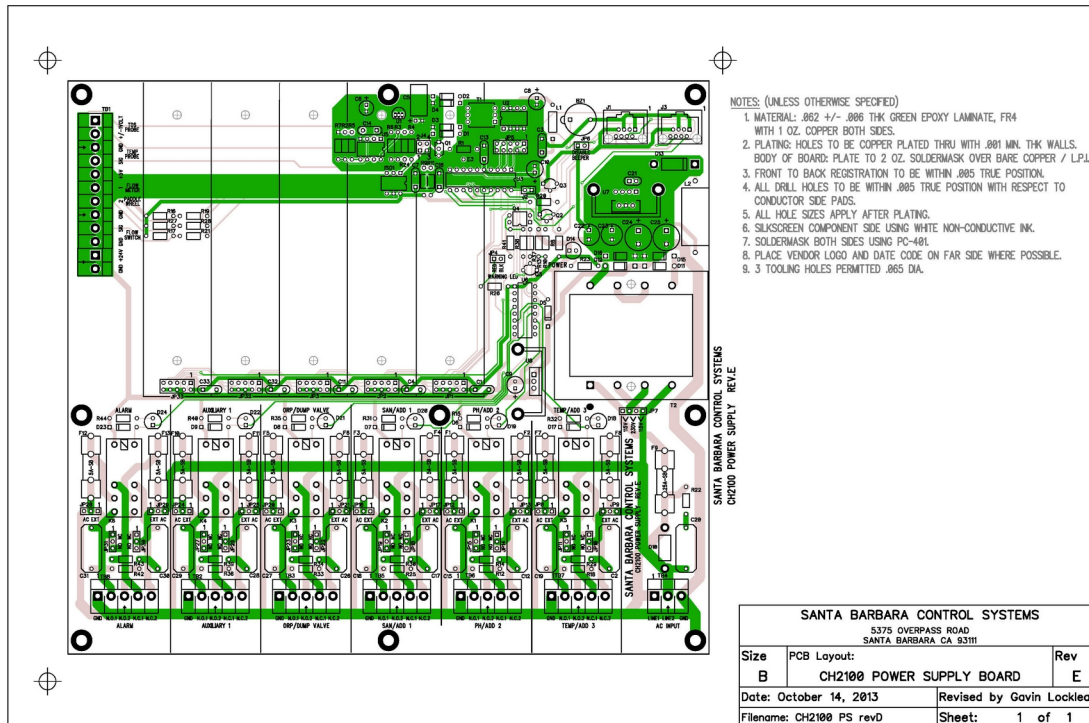

Figure 14. CH2100 Power Board

2.8.1 115V/230V Power Transformer

Each *CHEMTROL*® PC is equipped with a switchable, dual voltage power transformer that is mounted on the Power Board inside the cabinet.

The voltage selector jumpers are located on the right side of the board next to the power transformer. For 115V two jumpers are used as shown below. For 230V one jumper is used in the center as shown in Verify that the jumpers are set to the correct voltage, either 115 or 230V. Connecting the controller to higher voltage may cause damage to the electronics that is not covered by warranty.



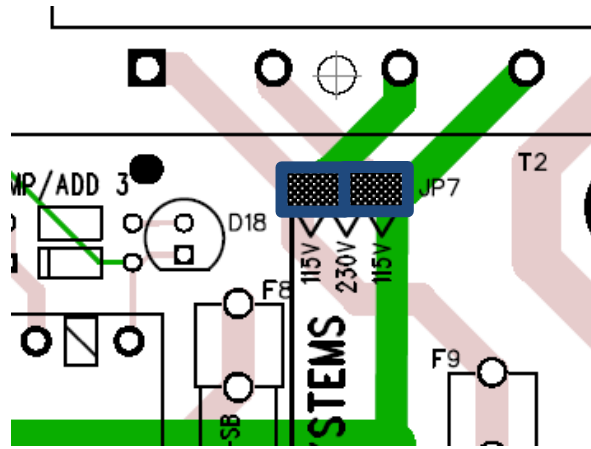

Figure 15. Voltage Selector Jumpers set to 115 volts (2 jumpers)

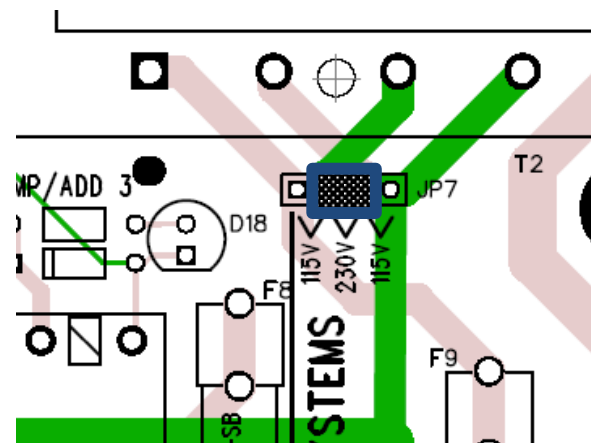

Figure 16. Voltage Selector Jumper set to 230 volts (1 jumper in center) 110v both (2) jumpers cover 4-pins



2.8.2 Relays and Fuses

NOTE: *The fuses for the Power Supply to each PC board are AGC-1 Slo- Blow.*

All other fuses for relay outputs are 5A Fast-Blow. All output relays are fused on the Normally Open (NO) and Normally Closed (NC) sides. Both the Hot and the Neutral sides are fused.

Make sure not to overload the relays. Chemical feed pumps normally draw less than 5A. If a pump draws more than 5A, it will need a motor starter or a magnetic switch.

The PC2100 uses jumpers on the Power Board to determine the connections for the output relays. These jumpers are normally set at the factory and should only be changed by a Qualified *CHEMTROL®* dealer.

The power board consists of several relays that are configurable. Each of the relays has a similar layout for the configuration. As an example, consider the ORP/DUMP VALVE relay with jumpers JP20, JP21, JP22, and JP 23.

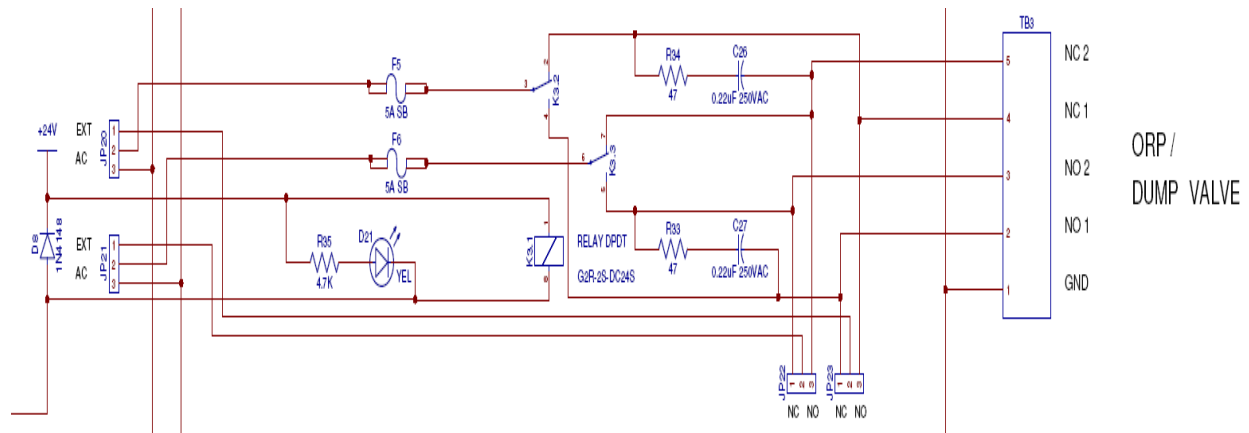

The jumpers are similarly placed on each of the relay positions. Two jumpers, labeled AC EXT control whether or not the AC power is routed through the relays. Below that are two more jumper blocks that control whether or not each relay is normally open or normally closed. Note that when the relays are used to switch AC, the normally open/normally closed terminals are directly available.



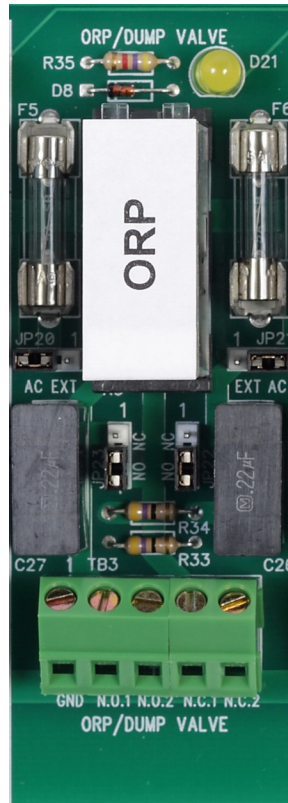

Figure 17. Typical Relay

Configuration	JP20	JP21	JP22	JP 23	Output Contacts
AC NO	2-3	2-3	Open	Open	NO1, NO2 (supplies AC)
AC NC	2-3	2-3	Open	Open	NC1, NC2 (supplies AC)
Relay 1 NO	1-2	1-2	Open	2-3	NO1, NC1
Relay 1 NC	1-2	1-2	Open	1-2	NO1, NC1
Relay 2 NO	1-2	1-2	2-3	Open	NO2, NC2
Relay 2 NC	1-2	1-2	1-2	Open	NO2, NC2

Table 6. Jumper Configuration



2.8.3 Remote Alarm

The remote alarm is a 5A DPDT relay located on the lower left of the Power Board labeled “ALARM”. The remote alarm relay can be set for dry or hot contacts, or for any external signal.

To avoid damaging the Power Board, make sure to use the right type of contacts. Call your dealer or the factory if you are not sure.

With hot contacts, the controller powers the alarm with 115V or 230V, depending on the setting of the input voltage of the controller (see preceding page). Connect the leads to the alarm to the Normally Open contacts (NO1 and NO2) on the terminal strip located next to the alarm relay.

With dry contacts, remove the two shunts from J1 located just below the fuses marked F7 and F8. Wire the remote alarm to NO1 and C1.

For an external power source, wire the input power to the terminals marked NC1 and NC2. Wire the remote alarm to the normally open contact (NO1 and NO2). The alarm voltage will be the same as the external power source.

2.8.4 Sensor Connections

All sensor connections are on the Terminal Barrier strips on the Power Board, as shown below. The pH and ORP sensors are then connected externally to the bulkhead BNC connectors on the left side of the cabinet. New configuration has them on Mother Board.

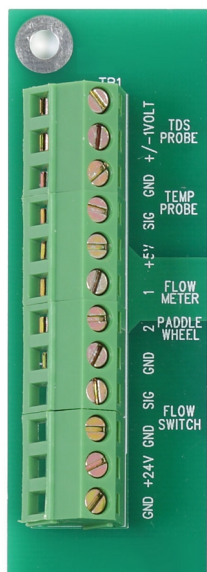
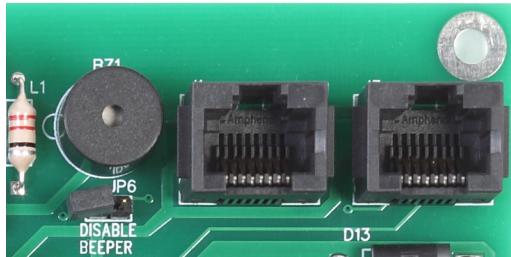

Figure 18. Sensor Connections on Power Board



2.8.5 Beepers

Each system contains two beepers. A beeper is located at the upper right of the Power Supply Board can be turned on for specific alarm conditions through the software program or for all alarms using the Audio Alarm Submenu. Jumper JP6 will disable the buzzer. Carefully note that the 8-pin connectors are power connectors. Do not connect Ethernet here.



Power Out to CPU Board Only
NO ETHERNET CONNECTION

The PC 2100 beeper is located on the right hand side of the main board and may be disabled with JP11

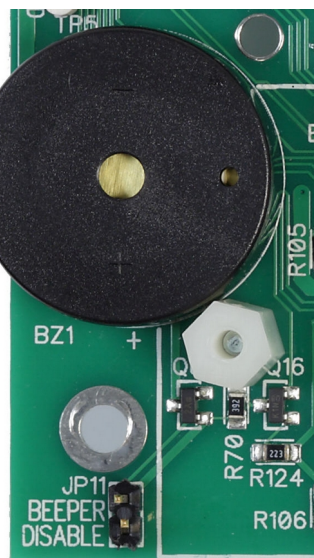

The PC3000, PC5000, 5100, PC6000, PC7000 and PC7100 series beeper is locate in the lower central area of the board. It may be disabled with JP13.

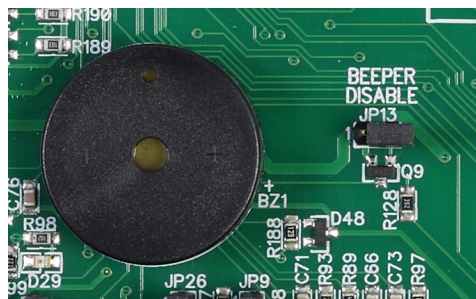

2.9 Piggy Back Boards

Piggy back boards are used to extend the functionality of a controller. Piggy back boards are used to add additional 4-20 mA signal I/O, additional ppm inputs, and additional backwash and general relay outputs.

Field Installation

For field installation, turn off all power to the controller. Position the converter board on top of the motherboard. Press the socket of the piggyback board onto the electrical header on the power supply board. Piggy back boards may be installed in one of five positions on the power supply board. Refer to your specific instructions for field installation.

2.9.1.1 4-in 4 out Stack

The 4-20 mA 4-in 4-out board (**Figure 19**) provides four additional inputs for pump influent and pump effluent pressures, and pH and sanitizer tank levels. In addition, four 4-20 outputs are also provided.



Figure 19. 4-20 mA 4-in 4-out



2.9.1.2 Four to twenty (4-20) mA 8-in 8 out Stack

The 4-20 mA 8-in 8-out stack consists of two boards: a base board (**Figure 20**) and a top board (**Figure 21**) board. The board set provides 8 additional channels of 4-20 I/O

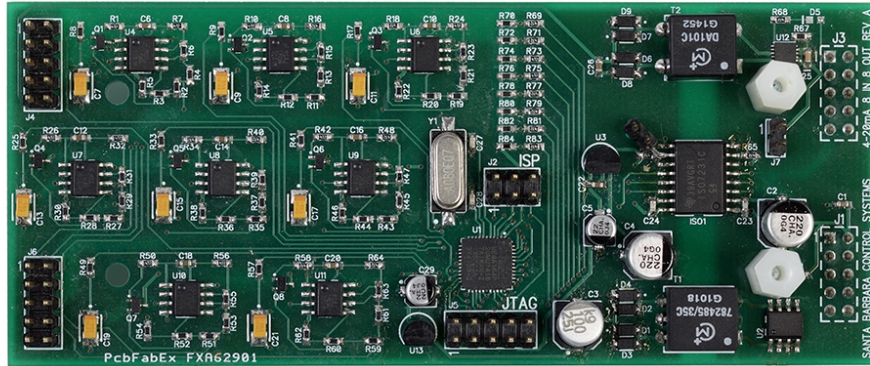

Figure 20. 4-20 mA 8-in 8 out Base

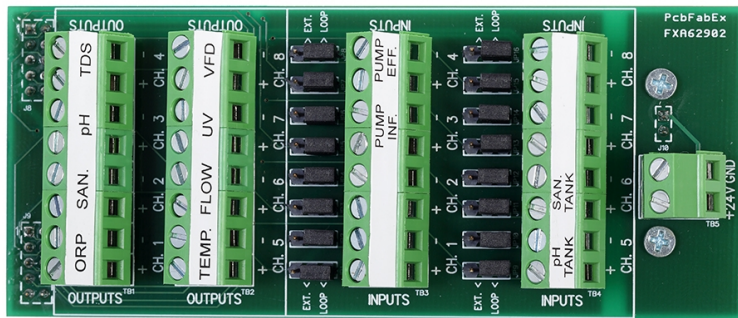

Figure 21. 4-20 mA 8-in 8 out Top



2.9.1.3 Four to twenty (4-20) ppm Module

The 4-20 mA ppm module provides an additional input for a ppm sensor.



Figure 22. 4-20 mA ppm Module

2.9.1.4 Backwash Relay Expander

The Backwash expanded provides an additional relay outputs for complex backwash requirements.

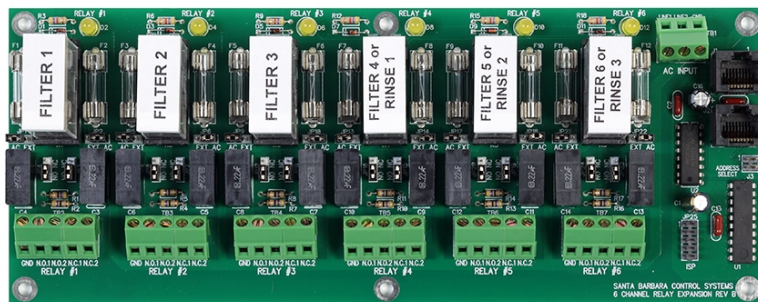

Figure 23. Backwash Relay Expander



2.9.1.5 Backwash Relay Expander for PC 6000

The Backwash expander for the PC 6000 provides an additional relay outputs for complex backwash requirements. The board is specialized to be used with the PC-6000 series controllers.

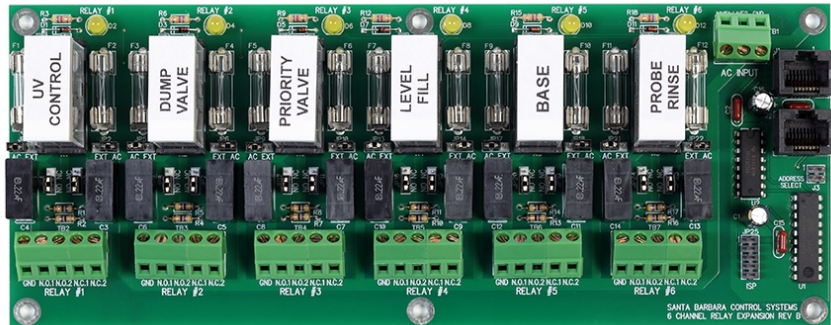

Figure 24. Backwash Relay Expander for PC 6000



2.10 Communications Adapters

2.10.1 RS-232 Adapter

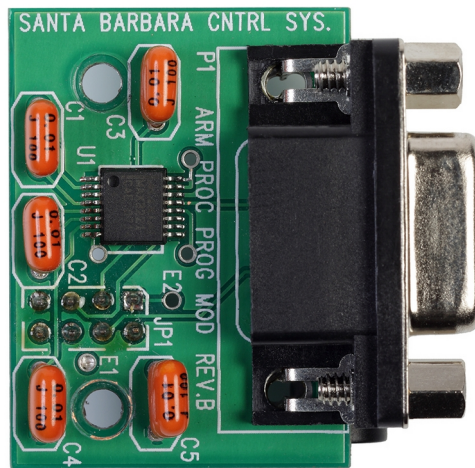

Figure 25. RS-232 Adapter

The RS-232 adapter is used to connect the ChemComm program

2.10.2 RS-485 Adapter



Figure 26. RS 485 Adapter

The RS-485 adapter is used to connect the Lantronix modules when required.



2.10.3 WiFi Adapter



Figure 27. WiFi Adapter

2.10.4 Processor Adapter

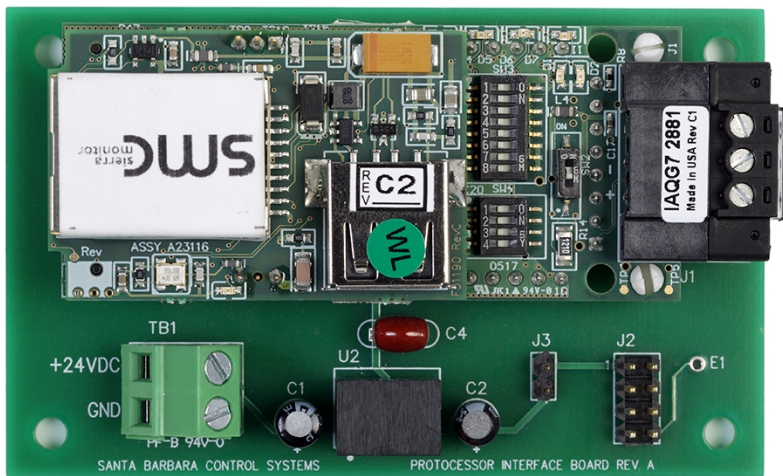

Figure 28. Protoceptor Adapter

2.11 Sensor Installation

2.11.1 Plumbing

This section covers the installation of the sensors and the connection of the chemical feeders or control valves.

All chemical injection should be done on the return line, i.e. downstream of the sensors and pool equipment, as explained in the Chemical Feeders section.

2.11.2 Installation of Sensors

The *CHEMTROL*® PC controllers use ten or more sensors for measurement of water chemistry, temperature, flow rate, pressure and water level:

1. amperometric sensor for Free Chlorine
2. total Chlorine
3. Bromine ppm
4. potentiometric sensors for pH and ORP
5. thermistor for temperature
6. conductivity sensor for Total Dissolved Solids
7. Hall effect pulse generator for flow rate or 4-20 mA
8. piezoelectric sensors for influent and effluent pressures 4-20 mA
9. electro-optical water level sensor
10. Tank level sensors
11. Flow line sensors (sonic)

The first five sensors measure water chemistry (Free Chlorine, ORP, pH, conductivity and temperature). Except for the Free Chlorine Sensor (must be on bypass line), these can be mounted directly on a 2-inch main recirculation line using PVC reducing tees. On larger diameter lines, they must be mounted on a ½-inch bypass line by using a Sensor Cell Cabinet

2.11.3 In-line Installation (2" Pipe)

On smaller installations (2" pipe diameter), the sensors can be mounted directly on the main recirculation line between the strainer and the pump. Sensors may also be mounted after the pump.



Use only 2x2x½ in. SST reducing tees without reducers. Do not install the sensors near an elbow or a constriction where there might be excessive turbulence.

Install the tees on after the filter and make sure that the tip of the sensor is oriented downward - to avoid formation of air pockets near the tip. Never mount the sensors horizontally. They should be mounted vertically or at a 45 degree angle. The sensors should be readily accessible for servicing but not exposed to physical damage.

After inserting the sensor, be careful not to over-tighten the compression fitting as it can crush the small glass tube inside the sensor. Make it finger tight (no wrench). Note that paddle-wheel flow switches cannot be used with this type of installation.

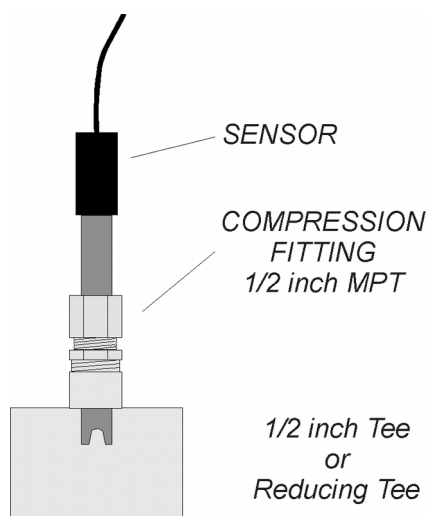

Figure 29. Sensor Installation

2.11.4 Flow Cell Assembly

For ease of installation and maintenance, the sensors should be mounted on the Flow Cell Assembly. It includes a sensor cell with an air vent and a clear cover, two compression fittings for the ORP and pH sensors, a water sampling tap and two ball valves for controlling the water flow in and out.





Figure 30. Flow cell Assembly

2.11.5 Sensor Cell Cabinet (Option)

For even greater ease of installation and maintenance, the components of the bypass line assembly can be supplied in a pre-plumbed Sensor Cell Cabinet (also called Wet Box). The Flow Cell Assembly is mounted in a fiberglass cabinet containing the sensor cell assembly. Also included is a paddle wheel safety flow switch. Install on a ½" bypass line, as shown.



Figure 31. Sensor Cell Cabinet (Option)



Make sure that the Sensor Cell Cabinet is located within 2 ft(60 cm) of the controller cabinet or other sensor extension cables. See wiring instructions in the ELECTRICAL section and operational instructions under WATER FLOW below.

2.12 PPM Sensors

The following PPM Sensors (Model 2010) are available with PC controllers:

- PPM002 for 0-2 PPM (mg/l) of Free Chlorine ppm FC010S
- PPM010 for 0-10 PPM (mg/l) of Free Chlorine ppm FC002

Both use the same membrane Part Number PPMEM1B

- PPM200 for 0-200 PPM (mg/l) of Free Chlorine with membrane part number PPM02
- PPMFC010S Sensor for electrolytic chlorine generators. (salt systems).



Figure 32. PPM Sensor

NOTES

1. These sensors are not affected by cyanuric acid.
2. All sensors use the same flow cell PPMCLL and do not require the plastic spacer ring.



Note that the sensor and mount components must be assembled completely and in the proper order as shown in the following diagrams.

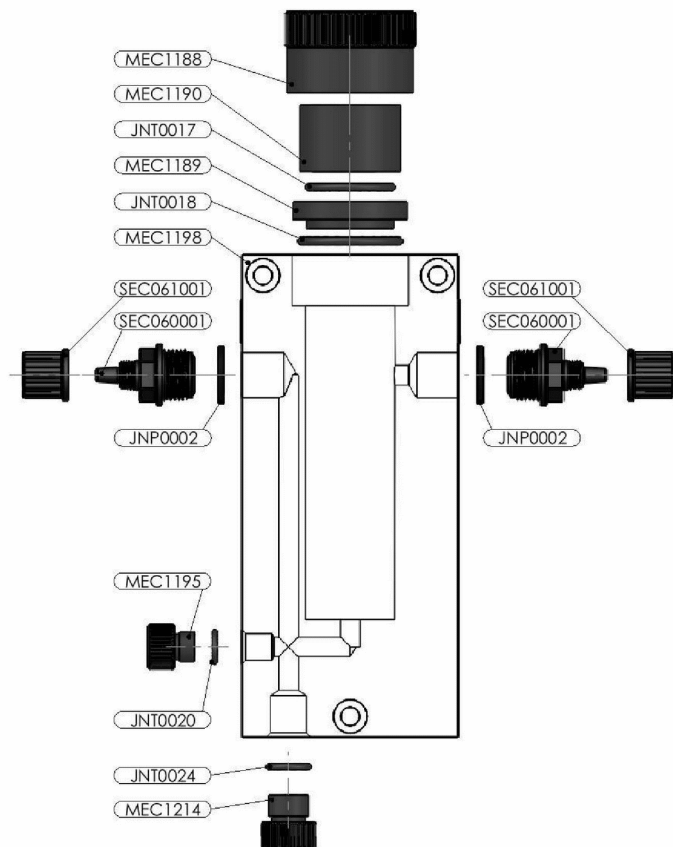
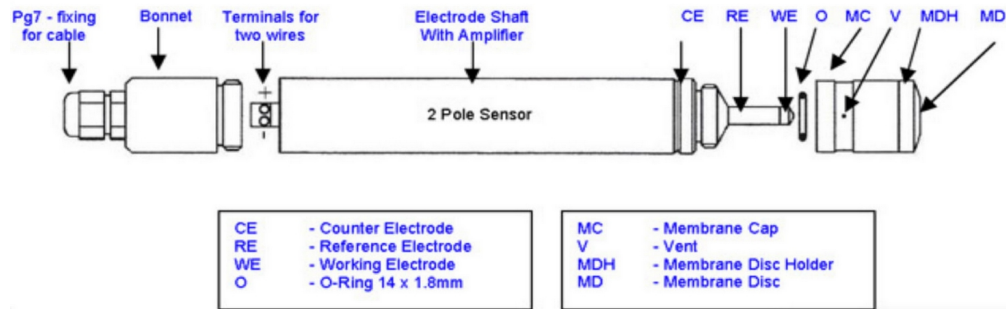

Figure 33. PPM Sensor and Mount



2.12.1 PPM Sensor Flow Cell

The PPM Sensor must be installed in the specially designed flow cell for better water flow control. Install the flow cell on a bypass line with 1/4" tubing as shown above.

Make sure that the bypass line is located after the filter and that there is a sufficient but not excessive flow of water. The ideal flow rate is between 40 to 60 liters/h (11 to 15 gal/hr.).

For a spa, it is recommended to increase the flow rate sufficiently to avoid the formation of air bubbles and to install the cell horizontally with the inflow coming in from the bottom.



Figure 34. PPM Sensor Flow Cell



2.12.2 PPM Sensor Installation

The new PPM Sensors are shipped in a molded foam package containing:

- One (1) chlorine sensor with warranty serial number,
- One (1) compression fitting with O-ring,
- One (1) electrolyte cap with membrane,
- One (1) electrolyte bottle and screw-on filling tip,
- One (1) screwdriver (not needed if pre-wired).



Figure 35. PPM Sensor Package

In order to prevent serious damage to the sensor, be careful not to touch the membrane or the electrodes. To facilitate shipment and storage of the sensor, it is not fitted with the electrolyte cap until ready for installation. The sensor cap must be filled with the electrolyte solution immediately before usage and emptied during storage.

Fill the sensor cap with the electrolyte taking care to prevent air bubbles. Fill the cap to the bottom of the threaded section. Thread the sensor into the cap as far as it will go while making sure not to touch the membrane film at the bottom with your fingers. Excess air and electrolyte may escape through the hole below the rubber seal. Wipe any excess



electrolyte with a soft tissue. Contact your CHEMTROL^(R) dealer if you need additional electrolyte.

Slide the O-ring over the sensor tip up to the compression ring. Finally, insert the sensor with O-ring in the flow cell and make it finger tight.

For best performance, it is recommended to change the membrane cap and electrolyte at least once a year. The code date is printed on the cable with three digits. The first digit is the year and the following two digits are the month.

2.13 ORP and pH Sensors

The ORP and pH sensors are non-corroding sealed combination electrodes. They do not require refilling. Each sensor has an external plastic body and an inner glass tube that can be broken if stressed too severely. The ORP and pH probes are shown in .

These potentiometric sensors produce small voltages - in the millivolts range. Since they have a high impedance (20 to 50 megohms), the electrical current produced by the sensors is extremely small - in the picoamp (10^{-9} A) range. The output is so small that it cannot be measured with ordinary voltmeters and must be internally amplified by the controller.

There is no electrical current flowing from the controller to the ORP and pH sensors. They are optically isolated from the high voltage circuit inside the electronic module.

The ORP (Oxidation-Reduction Potential or Redox) Sensor monitors the activity of the sanitizer (Fast Acting Free Chlorine, Bromine or Ozone) through its oxidizing power. It is recognized by its red color, the wide platinum band at the tip of the electrode and the white plastic tag on the cable.



Figure 36. ORP Sensor

The pH Sensor monitors the acidity of the water. It works with any acid or base. It is recognized by its blue color and by the glass bulb at the tip.



Figure 37. pH Sensor

2.13.1 Packaging

The pH and ORP sensors are shipped in individual cartons for extra protection. When ready for installation, remove the plastic cap on the tip of the sensor. If it is difficult to remove, dip it in water for a few seconds. It should then slide off easily. There may be a white crystalline deposit around the cap. This is produced by the salt solution that is used for shipping. It does not affect the performance of the sensor.

2.13.2 Sensor cables

The sensors are supplied with a standard 10' (3 m)-long cables made of coaxial wire designed to minimize electrical interference. For ease of identification, all ORP cables have a white marker.

The cables are terminated with bayonet-type, spring-loaded, push-and-twist male BNC connectors. These are connected to the proper female BNC connectors located on the left side of the controller cabinet.

If the cable is longer than needed, it should be coiled neatly and attached under the cabinet. **DO NOT ATTEMPT TO CUT THE SENSOR CABLE** under any circumstances.



If a longer cable is needed, custom-made extension cables with BNC connectors can be ordered from the factory in lengths of up to 1000 feet. For longer distances, a pre-amplifier may be required. Consult your dealer or the factory for details.

2.13.3 Electrical Interference

The *CHEMTROL*[®] PC controllers feature differential amplification of the sensor signals to reduce electrical interference from stray currents in the water.

To check for current leakage, compare the readings of the sensors when they are in line and when they are dipped in a plastic bucket containing the same water from the pool or spa. If you get different readings, there is current leakage. Its source must be identified and eliminated with proper grounding by a qualified electrician.



2.13.4 Storage and Winterizing

CAUTION:
STORING OR SHIPPING A
SENSOR WITHOUT CAP
OR WATER WILL VOID ITS
WARRANTY.

All ORP and pH sensors are shipped with a plastic cap on the tip to protect the tip from physical damage. This cap also contains water to prevent the sensor from drying out.

Remember to store the protective caps inside the sensor box or inside controller cabinet so that they are available for storage, winterizing or shipping. When storing or returning any sensor for warranty consideration, always add water inside the cap to prevent the sensor from drying out.

Freezing will damage the ORP and pH sensors. They should be removed from the line and stored at room temperature whenever freezing is expected.

Extended exposure to atmospheric conditions will cause the ORP and pH sensor tips to dry out. In contrast, the PPM sensor should be stored dry and electrically disconnected.

Always remove and properly store the sensors if the pool or spa is to be winterized or inactive. Store the sensors with the original cap provided, making sure that each cap is filled with the original storage solution or salt water.

If the storage containers have been misplaced, store the sensors individually in small glass or plastic containers with clean water covering the sensor tips.

2.13.5 Sensor Warranties

The PPM sensors are covered by a two-year manufacturer warranty. The pH and ORP sensors are covered by a standard one-year manufacturer warranty. This does not include damage caused by physical abuse such as breakage of the inner glass tubing or by drying out of the tip. **BE CAREFUL IN HANDLING THE SENSORS and ALWAYS REPLACE THE CAP WITH WATER INSIDE** when not in use.

In case of sensor failure, return it as soon as possible with its cap on and with water inside the cap for warranty consideration or replacement.



2.14 Temperature Sensor

If the CONDUCTIVITY option is not included, a separate Temperature Sensor is supplied as a thermistor embedded inside a ¼" MPT fitting with a 10-ft (3 m) connecting cable



Figure 38. Temperature Sensor

A 1/4" reducer epoxyed to a ½" SxS PVC tee is also supplied.

Install the sensor near the ORP and pH sensors, either directly on the main line or on the bypass line (flow cell) or sensor cell cabinet

Connect the red and black leads to the Terminal Barrier strip TB1 as indicated in Figure 18.
Sensor Connections on Power Board

NOTE: When the CONDUCTIVITY option (TDS) is specified, the temperature sensor is incorporated in the conductivity sensor. This simplifies installation, as only one sensor fitting is required.



2.15 Conductivity Sensor

The Conductivity or TDS (Total Dissolved Solids) Sensor consists of a dual measuring cell. It also contains a thermistor that is embedded inside the sensor. The sensor is supplied with a 10-ft (3-m) connecting cable and a specially drilled ½" MPT PVC fitting, as shown.

Using a ½" FPT PVC tee, install the sensor near the ORP and pH sensors, either directly on the main line or in a 90° elbow on the bypass line (flow cell) or sensor cell cabinet

Make sure that the sensor is oriented so that the water flows smoothly through the measuring cell.

The four leads from the conductivity/temperature sensor must be connected to the Terminal block strip TB1 on the Main Board or plugged into the side of the cabinet depending upon the installation. See Figure 44. Connections to PC2100 (Power supply board)



Figure 39. Combination Conductivity-Temperature Sensor



2.16 Water Flow Sensors

2.16.1 Magnetic Flow Sensor

Depending on pipe diameter, three different models of sensors are used for flow monitoring:

- Model 2536-P0 for diameters from 2 to 4 in (50 to 100 mm) (Figure 40),
- Model 2536-P1 for diameters from 5 to 8 in (100 to 200 mm) (Figure 40),
- Model 2536-P2 for lines over 10 in. (250 mm) in diameter)(Figure 40. Sensor Model P, P1, and P2).
- Magnetic Flow Sensor (**Figure 41. Magnetic Flow Sensor**)



Figure 40. Sensor Model P, P1, and P2

Connect the three leads from the sensor to the Terminal Barrier strip on the power supply board. Figure 44. Connections to PC2100 (Power supply board) or plug into flow socket on side of enclosure.



Signet 2551 Magmeter Flow Sensor



Figure 41. Magnetic Flow Sensor

The rotor shaft should be inserted at least 10% of the pipe diameter into the water. The sensors are paddle wheel-type rated at 200 psi (14 bar) at 68°F (20°C). The signal can be transmitted up to 1000 feet (300 m) without distortion.

Follow manufacturer instructions carefully and do not install while the line is under pressure.

Proper flow of water past the sensors is essential to obtaining good readings. To check the water flow in the bypass line, start the main recirculation pump. Open both the intake and the return valves on the bypass line and read the flow rate on the flow meter. It should be in the middle of the range, i.e. about 2-3 gpm (about 8 to 12 l/min). If the water flow is too high, reduce it by closing down the valve on the RETURN SIDE of the bypass line. If there is no water flow, replumb the bypass line as shown in Figure 8.

NOTE: The most common installation problems with bypass line or wet box installations are caused by faulty hydraulics.

To ensure proper water flow, make sure that the bypass line is properly connected. The intake side should be off the pressure side of the recirculation system, i.e. after the filter. The return side should be to a low-pressure area - such as the vacuum side before the recirculation pump, or downstream after the heater, or atmospheric pressure in the pit of a vacuum sand filter or balancing tank.



2.16.2 Paddle Wheel Rotary Flow Switch

The Rotary Flow Switch is a safety switch for the bypass line.

The switch contains a transducer that generates an electrical signal proportional to the water flow. The relay trip point is factory adjusted for a minimum flow rate of 1 gpm (about 4 l/min). (*Make sure to use the flow restrictor included in package. An adapter is available for low flow systems if required.*).

CAUTION:

Improper wiring will result in switch burnout (not covered under warranty).

The black, red and white leads should be connected to the contacts marked on the Mother Board, or into PWFS socket

- BLACK Ground
- WHITE Signal
- RED + 5VDC or +24 VDC



Figure 42. Flow Sensor

The clear window should be facing out for visual verification of the flow.

2.16.3 Flow Sensor Location

Always install the flow sensor as far away as possible from obstructions that can affect the flow profile past the sensor. Flow sensor manufacturers specify the length of unobstructed piping required before and after the sensor. This piping is required in order to obtain a non-turbulent flow past the sensor element. Straight piping is required both before and after the flow sensor.

Figure 43 shows requirements for a representative flow sensor. For example, given a typical 5 inch diameter pipe, the flow sensor should be mounted at least 50 inches past a flange



joint, at least 75 inches past a reducer, atleast 100 inches past a 90° elbow and so on. It should also be mounted with at least 25 inches of pipe down-stream of the sensor.

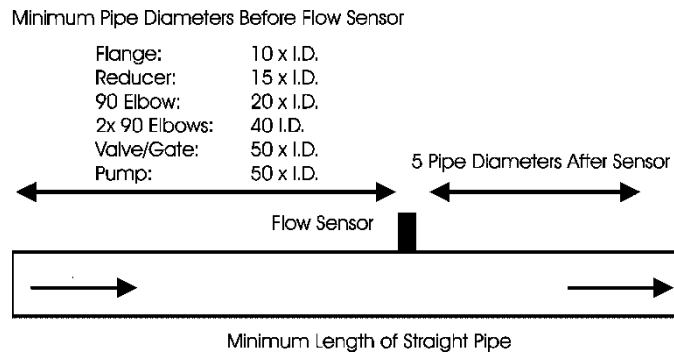

Figure 43. Flow Sensor Location

Saddle assemblies for flow sensors are available in 2, 4, 6 and 8 in. diameters and for larger sizes, call the factory for special order.

2.16.4 Flow Sensor Connections

Connect the three leads from the sensor to the Terminal Barrier strip on the power supply board

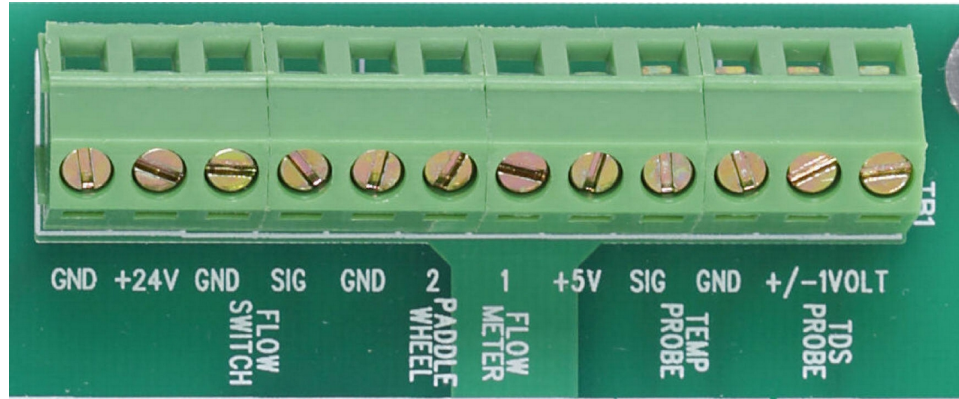

Figure 44. Connections to PC2100 (Power supply board)

- 5 V power and ground are available at the marked terminals.
- Frequency type flow meters are connected to the 1 Flow Meter terminal.
- Paddle-wheel flow meters are connected to the 2 Paddlewheel terminals



In addition, the PC 3000, PC 5000, and PC 7000 controllers have provision for 4-20 mA flow meters. (604 Board)

These are connected to TB13 The terminal block group has provision for 24v and ground connections.

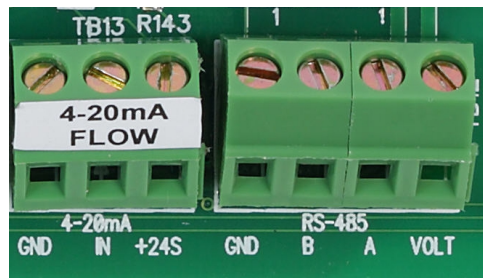
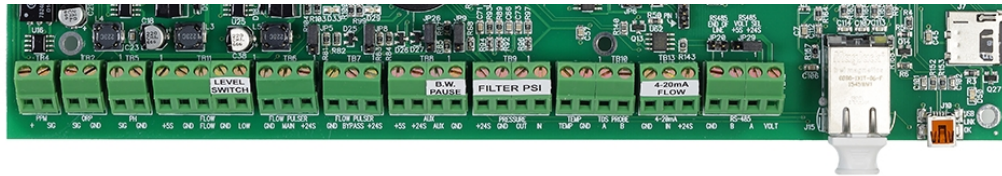

Figure 45. 4-20 mA Flow Meter Connections to PC 3000, PC 5000, pc 5100, PC6000, pc7000and PC 7100

CAUTION: A 4-20 mA signal is used . Older models use a 24 V DC signal. Reversing the wires will cause damage to the sensor and to the microprocessor.

Enter the **calibration K-factor** in pulses per unit of volume flow (gpm or l/m) for the specific pipe diameter and thickness, as discussed in Operations menu tree.



Chemtrol Systems typically utilize the FlowLine, EchoPod DL10 or DL24 Ultrasonic Liquid Level Sensors. Ultrasonic level transmitters have no moving parts, and measure levels without physical contact with the liquid.



Figure 47. Ultrasonic Level Sensor

2.18.1.1 Ultrasonic Level Sensor Installation

Wiring

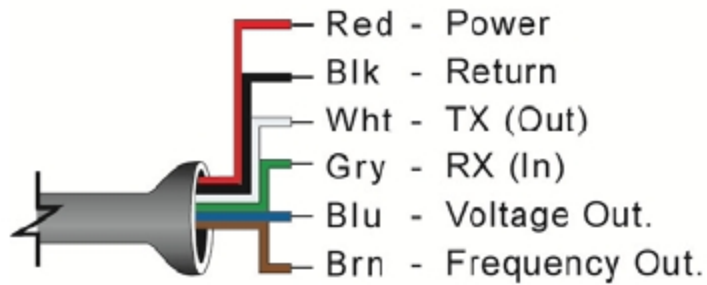

Figure 48. DL-10 Wiring



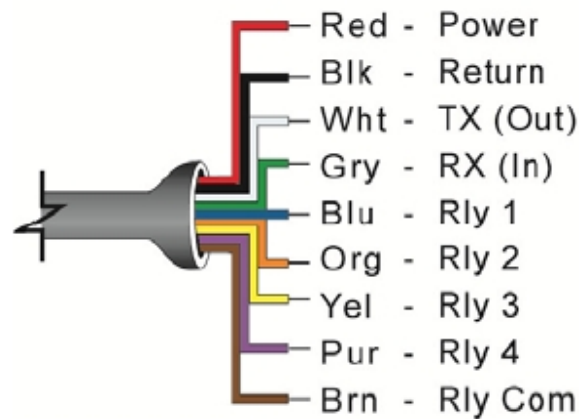

Figure 49. DL24 Wiring

Installation

The EchoPod® should always be mounted perpendicular to the liquid surface and installed using the provided Viton® mounting gasket. Make sure that the fitting and transmitter threads are not damaged or worn. Always hand-tighten the transmitter within the fitting. Perform an installed leak test under normal process conditions prior to system start up.

Note: The preferred mounting fitting for the DL10, DL14, DL24, DS14 & DX10 series is the LM52-1400 (2" thread x 1" thread) reducer bushing.

MOUNTING GUIDE

1. Do not mount at an angle.
2. Liquid should never enter the dead band.
3. Side Wall:
 - a. Mount at least 2" from the side wall.
 - b. For DL34 Series - mount at least 3" from the side wall.
4. Do not mount where obstacles will intrude into sensor's beam width.
5. Beam Width: 2" (5cm) diameter [3" (7.6cm) for DL34].
6. Do not mount in a vacuum
7. Avoid mounting in the center of a dome top tank.
8. In cone bottom tank, position the sensor over the deepest part of the tank.

INSTALLATION IN EXISTING FITTINGS



If the existing fitting is larger than the threads of the EchoPod®, select a reducer bushing such as the LM52-1400 (2" thread x 1" thread) or LM52-2400 (3" thread x 2" thread).



LM52-1400



LM52-2400

METAL TANKS (DL10, DL14, DL24, DS14 & DX10 SERIES)

Flowline ultrasonic transmitters have been optimized for use in non-metallic fittings.

1. For best performance, avoid the use of metallic fittings.
2. Use a plastic 2" x 1" reducer bushing, such as the LM52-1400 or a plastic 1" flange, such as the LM52-1850 for metallic tanks.
3. While installations directly into a 1" metal fitting are not recommended, acceptable results may be obtained if the 1" fitting is a half coupling in form and the outer diameter of the coupling is tightly wrapped in vinyl tape to dampen vibration.

FITTING SELECTION

Check the part number to determine the required fitting mount size and thread type. EchoPod® is commonly installed in tank adapters, flanges, brackets or standpipes. Note: Always include the gasket when installing the EchoPod®.

1. Tank Adapter: Select a tank adapter fitting, such as the LM52-1890 for the DL10, DL14, DL24, DS14 & DX10 series or the LM52-2890 for the DL34 series.
 - a. For best results, select a 2" tank adapter and add a reducer bushing such as the LM52-1400, thread x thread, reducer bushing.
 - b. Avoid tank adapter (thread x thread) styles and/or pipe stops forward of the installed transducer.
 - c. Always mount the tank adapter so the majority of the fitting is outside the tank.
 - d. Note: Never mount the tank adapter upside down or where the bulk of the material is inside the tank.



Do not use thread x thread

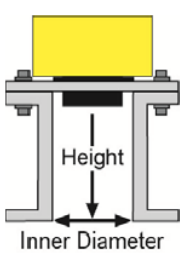

2. Riser: Installations with tall, narrow risers can impede the acoustic signal.
 - a. Core Out Concrete: Applications where a concrete tank ceiling has been cored out can also be considered as a riser type application. In these applications follow a 2:1 ratio (Inner Diameter to Core Height) for the diameter of the core.
 - b. DL34 Series: 2" (5 cm) diameter risers should be no taller than 4" (10cm). Larger diameter risers should be no taller than 12" (30.5 cm).
 - c. DL10, DL14, DL24, DS14 & DX10 Series:

	Riser Specifications	
	Inner Diameter	Maximum Height
	2" (5cm)	3" (7.6cm)
	4" (10cm)	8" (20cm)
	6" (15cm)	12" (30cm)

Note: Do not exceed the dimensions listed above.



Note: If attempting to raise the sensor above the top of the tank to allow for a higher fill capacity, avoid the use of tall and narrow risers. The example to the left exceeds the dimensions listed in the **Riser Specifications** chart. Use a larger tank adapter which takes into account the **Riser Specifications**.

3. Flange (DL10, DL14, DL24, DS14 & DX10 Series): If installing on a flange, select a flange with a thread that is above the plane of the flange, such as the LM52-1850.
 - a. The DL34 series works well with flange installations.
 - b. Avoid the use of blind flanges with tapped threads or flanges where the threads are even with the plane of the flange, such as the Banjo 1" Poly ANSI Flange (series AF100).
 - c. Use a flange with a 2" thread and add a 2" to 1" reducer bushing to complete the installation.

2" Flange w/
thread out of plane
(LM52-1850)



1" Flange w/
thread in plane



Do not use thread in plane

2" Flange w/
Reducer Bushing
(w/LM52-1800)



4. Side Mount Bracket: For installations in open tanks and sumps, use the LM50 series side mount bracket.
 - a. For the DL10, DL14, DL24, DS14 & DX10 series, order the LM50-1001-1, which includes a 2" x 1" reducer bushing.
 - b. For the DL34 series, order the LM50-1001 side mount bracket.

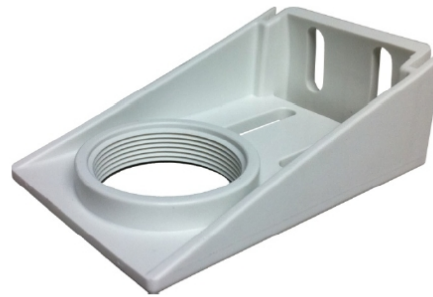
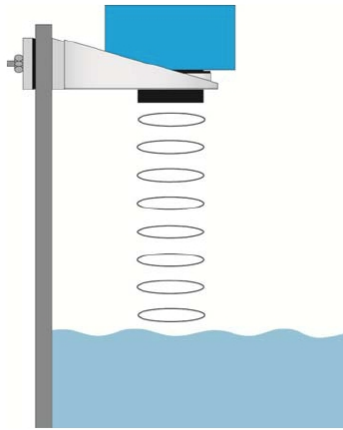

LM50-1001 Shown

Note: The Side Mount Bracket (LM50 series) is not designed for use with stand pipes or as a method to secure stand pipes. There are too few threads to properly hold the sensor and the stand pipe.

5. Stand Pipe: A standpipe maybe used to dampen turbulence or separate surface foam from the point of measurement in the application.
 - a. Pipe can be made of any material.
 - b. Select a 3" ID pipe for the stand pipe.
 - i. A 2" pipe (minimum pipe size) is usable with the DL10, DL14, DL24, DS14 & DX10 series. Minimum pipe size for DL34 series is 3" ID.
 - ii. Pipe series larger than 3" can also be used.
 - c. Use a coupling and reducer bushing to attach the EchoPod® to the pipe.
 - i. Use a plastic reducing bushing such as LM52-1400 (2" T x 1" T) fitting or the LM52-1410 (2" S x 1" T) fitting.
 - ii. For the DL34 series, use a plastic reducer bushing such as LM52-2400 (3" T x 2" T) fitting or the LM52-2410 (3" S x 2" T) fitting.
 - d. The pipe length should run the measurement span and the bottom of the pipe should remain submerged at all times to prevent foam from entering the pipe.
 - e. Cut a 45° notch at the bottom of the pipe and drill a 1/4" pressure equalization hole within the dead band of the sensor.
 - f. The pumps should not drive liquid past the open end of the stand pipe which causes the liquid in the pipe to oscillate.



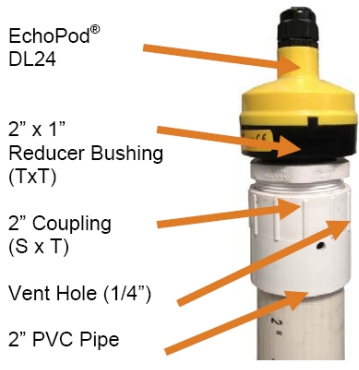

DL24 attached to a LM52-1400 (2"x1" reducer bushing) and 2" Coupling (S x T).



Avoid the use of a tee within the stand pipe. A tee can create false signals that will negatively effect the sensor's performance.



2.18.2 Optical Level Sensor

The water level in the pool can be automatically maintained with a fill valve controlled by the water level sensor. The sensor is an ELS-1100 Series electro-optical sensor with a 1/4" NPT thread. The sensor is may be located in the pool or in the surge pit

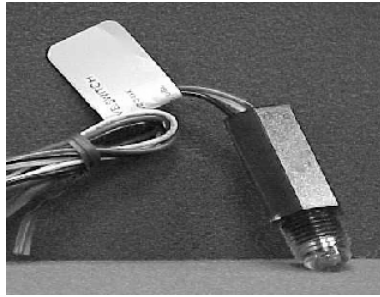

Figure 50. Optical Level Sensor

The optical sensor uses the reflection of an LED light beam inside a prism to determine the position of the water level (

). With no liquid present, the light beam from the LED is reflected within the prism to the receiver. When the liquid level reaches the prism, the index of refraction is changed and the beam is cannot be detected by the receiver.

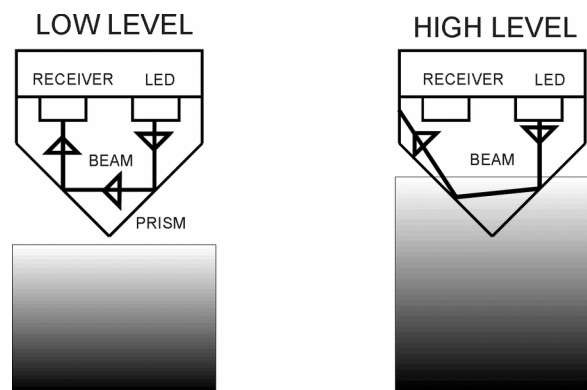

Figure 51. Optical Beam Path

For best results, the surface of the prism must remain clean.

2.18.2.1 Optical Level Sensor Installation

Locate the sensor in a convenient location in the pool, surge pit or water tank as shown on



. Wire the fill valve to the Level Fill relay.

Connect the leads from the sensor to the Terminal Barrier strip TB1 as indicated.

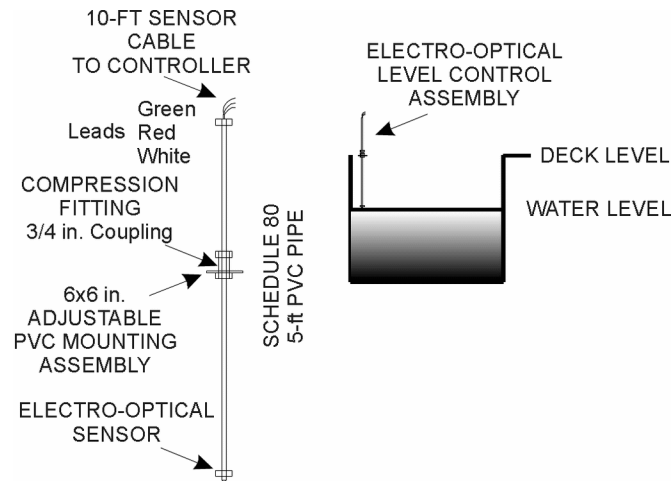

Figure 52. Water Level Assembly

2.18.2.2 Level Sensor Wiring

The level sensor switch is wired to the LEVEL SWITCH inputs on the PC 3000 and above.

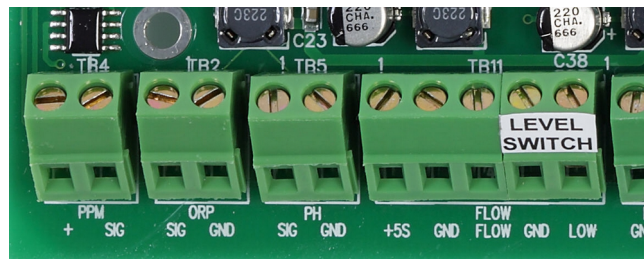

Figure 53. Level Switch inputs (PC 3000 and above)

2.18.2.3 Optical Level Sensor Maintenance

The surface of the prism should always be kept clean and should be positioned at least 2" (cm) away from reflective surfaces.



3 Chemical Feeders

3.1 WARNING: Tank Sizing

The *CHEMTROL*® PC controller includes many safeguards to prevent overfeeding of chemicals. However, there is always a risk of physical failure of the electronics or feed equipment that could cause overfeeding of chemicals. To prevent damage or injury to persons, it is imperative to size the chemical tanks so that no dangerous amount of chemicals will be fed in case of equipment failure.

3.2 Chemical Feed Pumps

Chemical feed pumps are used to feed liquid sanitizers, such as sodium hypochlorite NaOCl, also known as liquid chlorine, or solutions of calcium hypochlorite or dichlor powder. Liquid chemicals for pH control include muriatic acid, caustic soda or solutions of soda ash.

Any standard chemical feed pumps (diaphragm, piston or peristaltic) approved by NSF (National Sanitation Foundation), UL (Underwriters' Laboratories), ETL (Electrical Test Laboratories), CSA (Canadian Standards Association) or similar national and international organizations, can be used, as long as they are properly sized for the installation.

Install the pumps as shown in Figure 8 following the electrical code and the pump manufacturer's instructions.

3.2.1 Carbonic Acid (CO₂) Valve

A special solenoid valve for carbonic acid can be used to control the addition of CO₂, an acid used to lower pH. In large pools, it is typically used in conjunction with muriatic acid (HCl) to control pH and total alkalinity.

3.2.2 Gas Chlorinator

NOTE:

Use of Chlorine gas is very dangerous.

Make sure to follow all local safety codes.

Gas chlorinators should be installed and maintained only by factory-trained technicians following the instructions of the manufacturer.

If required, the injection line for chlorine gas can be controlled with a specially designed, corrosion-proof solenoid valve installed between the gas chlorinator and a Venturi injector.



Alternatively, a magnetic starter can be used to control a booster pump for the chlorinator bypass line.

3.2.3 Erosion Feeders

Erosion feeders for bromine, chlorine or calcium hypochlorite tablets can be controlled with a solenoid valve that is mounted on the intake side of the bypass line before the feeder (). This allows the controller to modulate the flow of water through the feeder. For proper valve operation, the pressure differential through the feeder must be at least 15 psi (1 kPa). This may require installation of a pump on the bypass line.

With less corrosive chemicals, such as bromine dihalo or calcium hypochlorite tablets, the solenoid valve can be mounted before the erosion feeder.

Back Diffusion

With corrosive trichloro tablets, it is recommended to protect the solenoid valve with a check valve and an anti-diffusion loop, as shown in Figure 54.

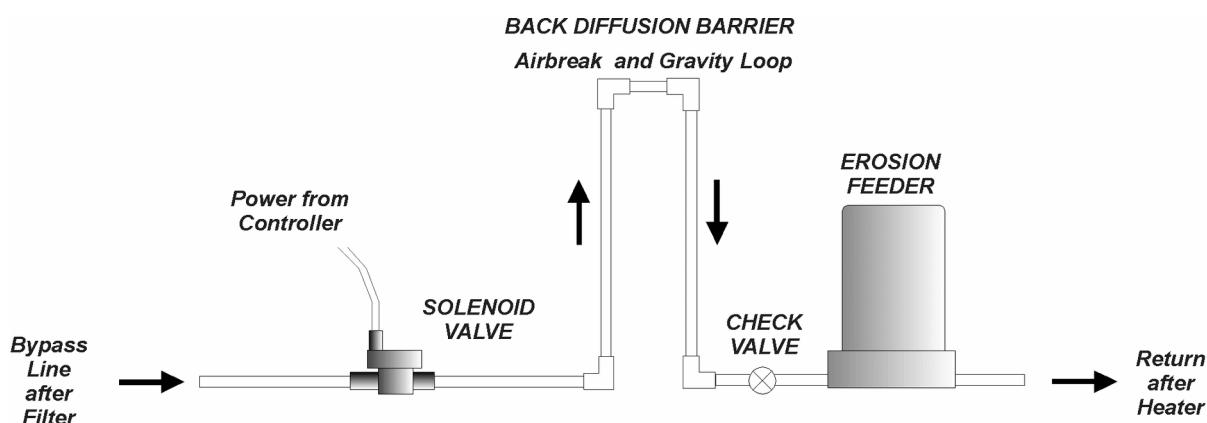

Figure 54. Erosion Feeder Control

The loop must be narrow to facilitate formation of an air break and tall to maximize the effect of the gravity barrier.

This design reduces – but does not eliminate – corrosive back diffusion. A better idea is to switch to a less aggressive sanitizer.



3.3 Filter Backwash

The Power Board of the *CHEMTROL* PC4000 – PC6000 series includes six (6) double-pole, double-throw (DPDT) 5A relays for automated filter backwash. They can be used to control solenoid valves, motorized valves, hydraulic valves or pneumatic valves.

3.3.1 Main Pump Shutoff

To relieve pressure on the backwash valves, it may be desirable to shut off the main recirculation pump during opening and closing of the valves.

Use Filter Submenu in the *CHEMTROL* PC4000 – PC6000 series to specify if the main recirculation pump is to be shutoff during cycling of the valves. The standard shutoff value is 5 seconds but it can be changed.

3.3.2 Single Filter Backwash

As shown in Figure 55, backwashing of a single filter is controlled with four valves that are connected to the Normally Open (NO) and Normally Closed (NC) poles of Filter Relay 1.

Valves # 1 and #4 are connected to the Normally Open connectors on Relay #1 (marked NO1 and NO2). These valves are open for filtration and closed for backwash.

Valves # 2 and #3 are connected to the Normally Closed connectors on Relay #1 (marked NC1 and NC2). These valves are closed for filtration and open for backwash.

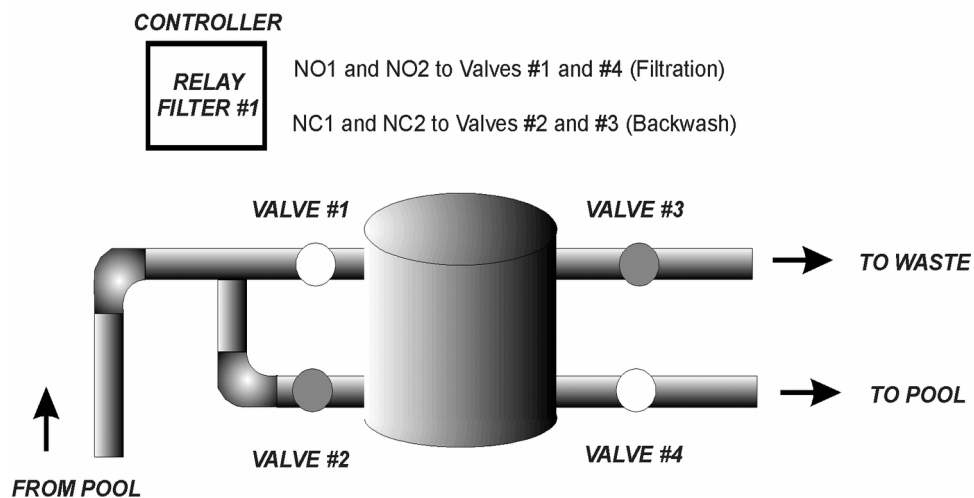

Figure 55. Single Filter Backwash



3.3.3 Multiple Filter Backwash

The connections for sequential backwashing of multiple filters with three-way valves connected to Filter Relays 1 to 6 are shown below. If more than six filters are used, several filters can be banked together.

For filtration, the valves are in the normally open position and connect the influent and effluent lines through each filter. In backwash operation (normally closed), the valve is connected to the waste discharge line.

A partial closure valve (priority valve or flow control valve) can be connected to the relay marked Deoxidizer. Specify in Submenu 7.8.1 if it is to be activated during backwash.

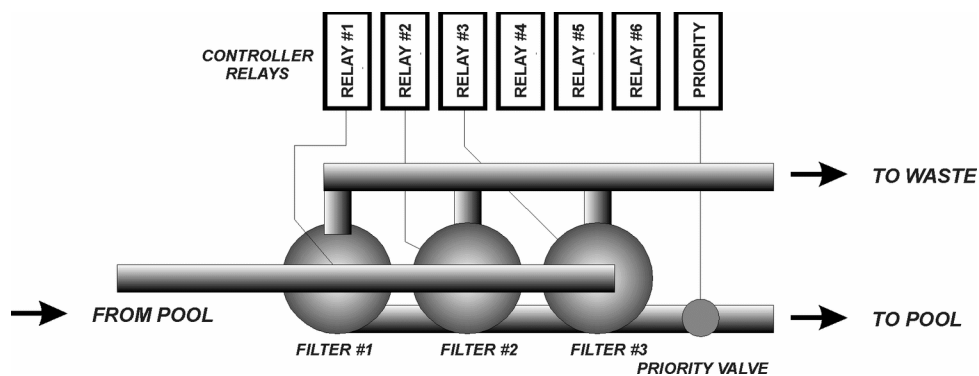

Figure 56. Multiple Filter Backwash

3.3.4 Backwash Stager

Multiple filter backwash can also be done with a backwash stager, a mechanical port selector for multiple filters that can be used in place of solenoid valves.

The stager is operated through a dry contact relay connected to Filter Relay #1 on the Power Board.



4 Electrical Valves

4.1 Solenoid Valves

Solenoid or motorized valves can be connected directly to the NO and NC sides of the filter relays if they draw less than 5 A. If more than 5 A, an intermediate relay of sufficient amperage should be installed.

4.2 Hydraulic Valves

Water pressure for a hydraulic valve can be controlled with a three-way piston valve, one port being used to apply water pressure for backwash and one port open to the atmosphere to relieve the pressure on termination.

4.3 Pneumatic Valves

Air pressure to pneumatic valves can be controlled with a standard two-way solenoid valve installed on the air line.



5 Controller Operation

This Chapter describes the menus and submenus used to operate the *CHEMTROL*® PC controllers. For an overview, refer to the Menu Tree (Section 5.5).

5.1 Control Panel

The Chemtrol Controller has an eight line display and a 16 button key pad. The active line in the display is shown by a reverse-video line (dark characters on a light background). The active line may be moved up and down by the up and down arrow buttons. The operator navigates through all the menus and submenus with four directional arrow keys: UP, DOWN, LEFT, and RIGHT.

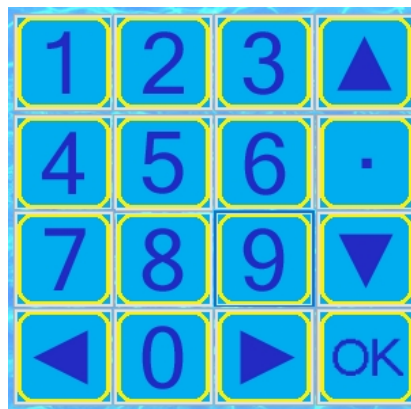

Figure 57. Key Pad

The brightness of the display screen is adjusted at the factory before shipping. If required, it can be re-adjusted at any time with the potentiometer marked R39.on the main board (Figure 10) inside the cabinet.

Note:

After a parameter is changed you can return to the previous menu via the right arrow. If you have entered in a numeric setup item, you must press OK to accept the item and progress to the next item.



5.2 Welcome Screen

When power is applied to the controller, the *CHEMTROL*® PC displays the Welcome Screen shown:

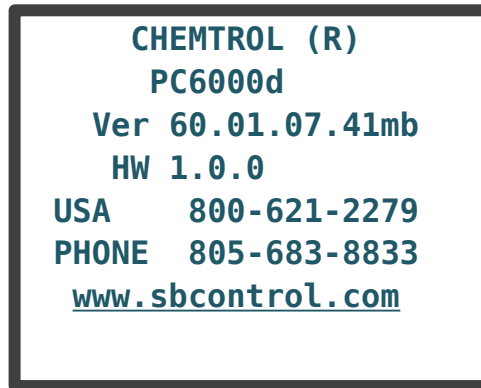

Figure 58. Welcome Screen (Typical)

The welcome screen includes the version of operating software installed on the controller and the numbers for Technical Support from the factory by phone 805-683-8833 or by fax 805-683-1893. In the USA and Canada, technical support is also available toll-free at 800-621-2279.

After a short time the Main Display appears. The welcome screen can also be accessed at from the Main Display by pressing the LEFT ARROW key.

5.3 Main Display Readings

A sample main screen is shown below:

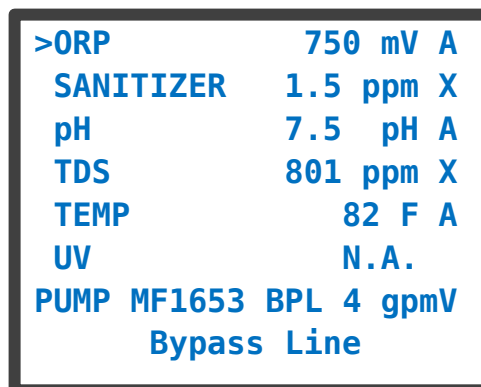

Figure 59. Main Screen



Here the active line is the date and time line (it is highlighted). Any line that may be flashing indicates an alarm condition.

Figure 59. Main Screenshows a typical operation of the pool controller. This screen indicates:

- Line 1 shows an **ORP reading of 750 mV** with the feed pump in Automatic feed mode (A) and running (>).
- Line 2 shows a **Sanitizer level of 1.5 ppm** with the feed mode OFF (X).
- Line 3 shows a **pH reading of 7.5** with the Acid feed mode in Automatic (A) and the pump not running (no >).
- Line 4 shows the **Total Dissolved Solids (TDS) at 801 ppm** and bleed valve control OFF (X).
- Line 5 shows a **Temperature reading of 82 F** with the heater control on Automatic (A).
- Line 6 shows **Flow Rates of 1653 and 4 gpm** in the Bypass line and Main line and the Pump in Manual mode (M).
- Line 7 Blank
- Line 8 shows the **Date and Time** and an indication that the **water saturation index is OK**. The line is highlighted to give access to the Configuration Menu.

Each line displays operational information on five columns, from left to right:

1. Operational status (ON or OFF) with a small caret ">" indicating outlet activation. If the caret is flashing it indicates that the outlet is pausing before activating again.
2. Function identification: ORP, SANITIZER, pH, CONDUCTIVITY, TEMPERATURE, PUMP
3. Sensor readings
4. Units of measurement (US or metric)

The operational mode is represented by a single letter:

- A for automatic control,
- M for manual operation,
- P for proportional control
- T for timer control,
- X for OFF.
- V VFD for main pump



Alarm conditions are shown in two ways: operational parameters that are over or above limits are shown by flashing the corresponding line in the main display (ORP, sanitizer, pH, TDS, temperature, pump). Other alarm conditions are shown by flashing text in the lower right corner of the display (Probe failure, out-of-range, overfeed)

- Probe Indicates a probe has failed
- LSI OK Indicates the Langlier Saturation Index (LSI) within limits
- Scale The LSI is above the set limit indicating a scaling condition
- Corr The LSI is below the set limit indicating a corrosion condition

If the display shows an alarm condition, press the UP or DOWN arrow keys to select the flashing line and enter the submenu with the RIGHT ARROW key to determine the cause of alarm. Press the LEFT ARROW key to exit from any submenu

5.4 Default Setup

The controller is initially loaded with standard default values that allow it to start operating normally. It is therefore not required to initialize it in order to operate the controller, as it defaults automatically to standard setup values:

- “English” language,
- “U.S. Units”,
- “No password”,
- Standard set points and alarm values.

The operator can change the original default settings at any time to suit preferences. If needed, the original default values can also be restored through the Reset menu. They will always be automatically restored in case of complete loss of power, including backup battery power.

The main menu is the gateway to the setup and configuration menus. The menus vary from model to model and upon the various options ordered with each unit.

A typical menu is shown below. Press the left arrow to bring up the version screen. The version screen identifies the unit and is necessary for accurate diagnosis and trouble shooting.



The setup and operational menus are accessed by moving the selection bar to the desired parameter using the up/down arrows then pressing the right arrow.

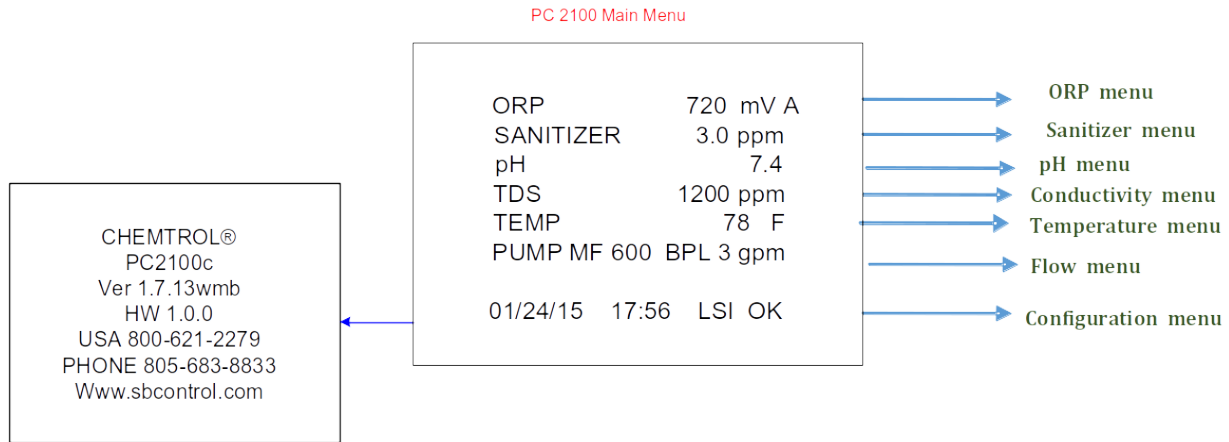

Figure 60. Typical Main Menu for PC 2100 series controllers

Each of the menus is described in the following sections.

5.5 Configuration Main Menu

The Configuration Menu is used for Initial Setup, Operations, and Communications.

To access the Configuration Menu, use the UP and DOWN ARROW keys on the Main Menu screen to highlight the time/date line (the bottom line) and then press the RIGHT ARROW key to enter the Configuration menu.

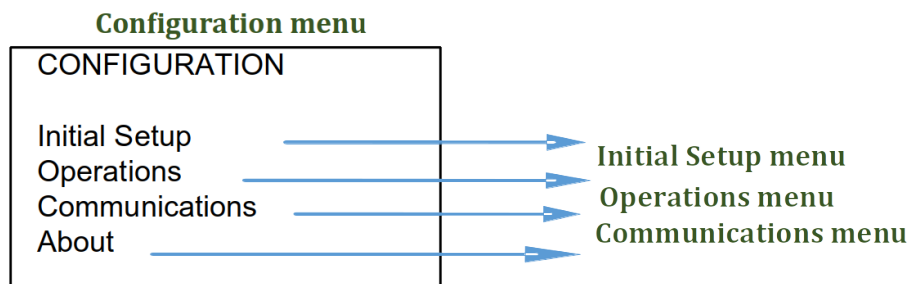

Figure 61. Configuration Menu



5.6 Initial Setup

The Initial Setup menu is used to specify basic operating conditions of the *CHEMTROL®* PC. Access the Initial Setup menu from the configuration menu by positioning the highlight bar over the Initial Setup line and pressing the right arrow.

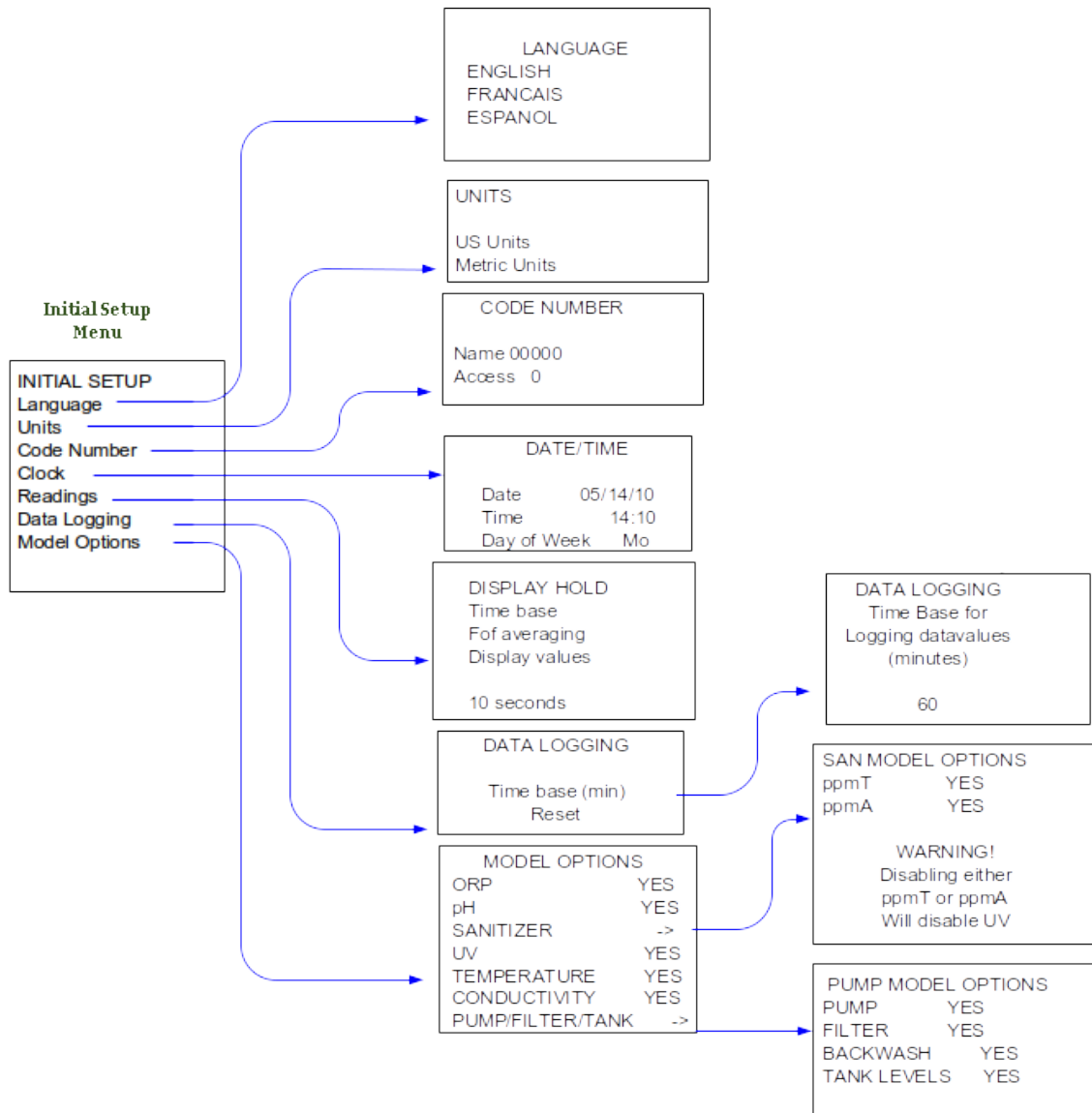

Figure 62. Initial Setup



5.6.1 Measurement Units

The unit equivalencies are:

	US	Metric
ORP	mV	mV
Sanitizer	ppm	mg/l
pH	pH	pH
Conductivity	μ S	μ S
TDS	ppm	mg/l
Temperature	F	C
Pressure	psi	kPa
Flow Rate	gpm	l/m
Flow	Mga	m ³

Table 7. Unit Equivalencies

5.6.2 Code Numbers

The Code Number Submenu is used to define operator access levels. Code numbers may be required for access at key points in the program.

Up to ten Code NUMBERS (of one to five digits each - no letters) may be entered, along with an associated access level from one to three. Make sure to select an easy to remember number, such as a familiar name on a standard telephone keypad.

The following access levels are available:

- Level 0: Delete Access Number
- Level 1: View only,
- Level 2: Calibration,
- Level 3: All functions.

Once a Code Number has been acknowledged, it remains valid for an hour of continuous operation so that the operator does not have to re-enter it constantly. If necessary, it can be changed by returning to the Welcome screen.

Entering Access codes

1. Using the arrow keys, navigate to the Code Number submenu.



2. Highlight the Name line and press right arrow. Only the Name numbers should be highlighted.
3. Enter the Code name (e. g. 333).
4. Press OK. **(You must press OK to enter the number. Pressing the right arrow will not make any changes)**
5. Press the down arrow and move the highlighted line to the Access line.
6. Press the right arrow (only the Access code should be highlighted)
7. Press desired access level (1, 2, or 3)
8. Press OK to enter the access code. The entire line will highlight)
9. Press the left arrow four times to activate the code.

When entering codes, be sure to enter your level 3 code name first. (Otherwise, you will be locked out.) Enter all the access level three codes first, followed by the access level two and one codes.

When deleting codes (setting the access level to 0) delete the level 3 codes last.

If some codes have been forgotten and you need to delete them, you must do a complete reset and reenter all parameters.

5.6.3 Clock Setup

The clock/calendar is used for programming of daily and weekly schedules. It keeps track of odd months and leap years. In case of power shutdown, the backup battery maintains power to the board. The clock needs to be reset only in case of complete power shutoff with loss of battery power.

The date display uses the MM/DD/YY (Month/Day/Year) format and the time display uses the 24:00 hour format (00:00 to 23:59).

5.6.4 Readings Setup

The Readings menu sets the DISPLAY HOLD parameters. It is used to stabilize the readings by averaging and increase the stability. It specifies the time interval over which the sensor data is averaged before the screen is updated. It can be set between 1 and 60 seconds with a default value of 10 seconds.

5.6.5 Data Logging

The DATA LOGGING screen selects the time interval for storing test data in the controller memory. Intervals can be between 1 to 999 minutes, with a default value of 60 minutes.



The memory of the controller chip can store up to 999 readings. When full, the oldest readings are overwritten by the newer ones. Therefore the greater the interval is, the more data can be kept in the controller. For instance, an interval of 60 minutes (one hour) fills the memory in about 41 days. If data logging is set to every four hours, the controller will hold 5 ½ months of data.

To avoid losing test data, remember to download it to a computer or the SDchip before the memory is full (Print Reports). After data download is completed, the Reset function can be used to remove all data and start with a clean slate.

Set the time base by moving the highlight bar to the time base line and press the right arrow. Enter the desired time base followed by the OK button.

The Reset option is used to reset the controller setup parameters.

5.6.6 Model Options

The Model Options Submenu is used to specify the functions that are actually installed on the controller. Non-installed functions should be set to “NO”. The Main Display Screen will then show N/A for that function.

For demonstration purposes, it is possible to access any function and review its features even if that feature is not actually installed on the controller, by selecting “YES” for that option. Model Options are ORP, pH, Sanitizer, UV, temperature, conductivity, and pump options.

Each of the options may be selected or deselected by move the Highlight bar to the corresponding line and pressing RIGHT ARROW. Press LEFT ARROW to return to the previous menu.



5.7 Operations Menu

The Operations Menu allows the operator to access and change operating conditions during normal operation. Access the Operations menu from the configuration menu by positioning the highlight bar over the Operations line and pressing the right arrow.

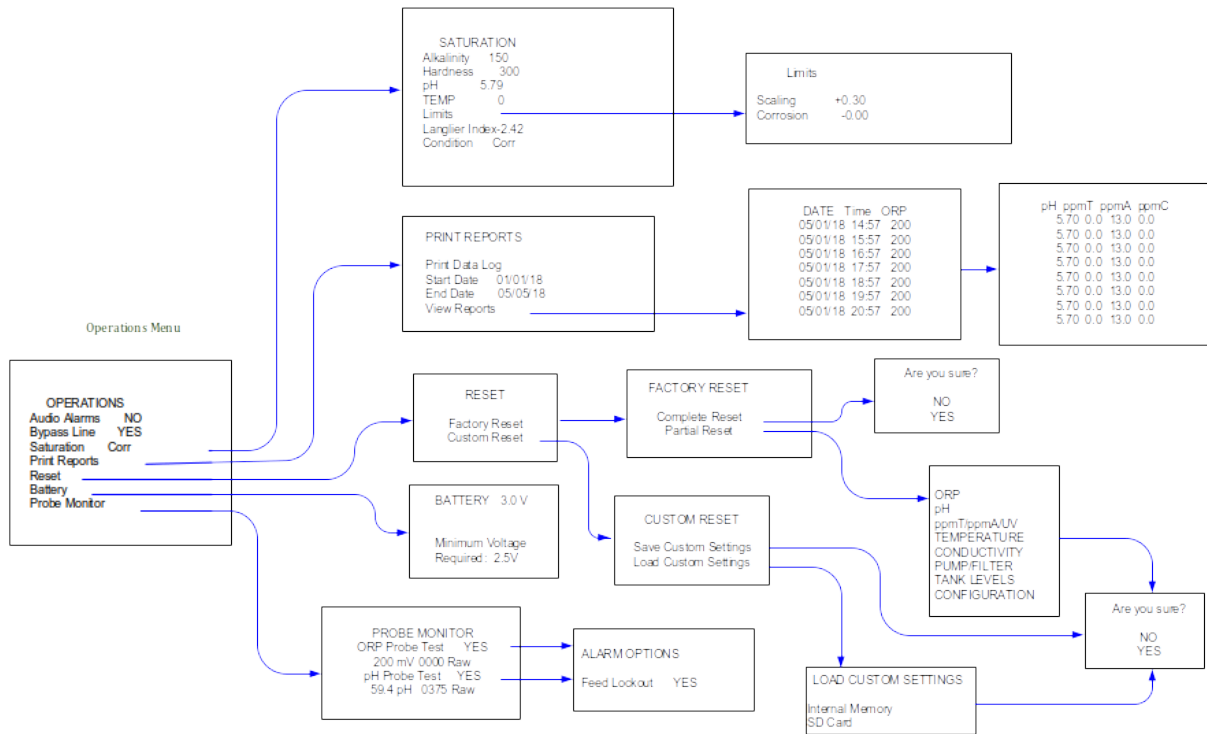

5.7.1 Bypass Line Submenu

The bypass line is a recommended feature installation on large recirculation lines, i.e. over 2 inches in diameter. It is included with all PC controllers.

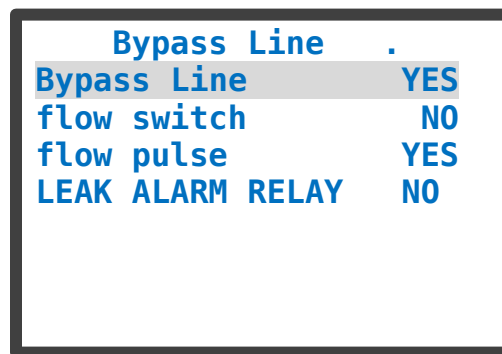

Figure 63. Bypass Menu



A Safety Flow Switch is used to prevent operation when there is insufficient water flow in the bypass line. This can occur particularly when the bypass line is shut down for maintenance.

In addition, units have the ability to accept a secondary blade or continuity flow switch. This can be installed on the main line so that either flow switch can disable chemical feed.

WARNING:

Feeding chemicals when there is no water running in the bypass line may cause dangerous chemical reactions.

The standard flow switch provided with the *CHEMTROL*® PC is a rotary flow meter with a paddle wheel. The shutoff is set at 1 gpm (about 4 l/m).

The Bypass Line Protection option should always be set to YES, indicating that the alarm is active and will cause the interruption of all feed events.

If the flow switch is defective or temporarily disabled, the bypass alarm can be overridden by setting the Bypass option to NO. **This override should be used with extreme caution.**

5.7.2 Saturation Menu

The Saturation Menu is used to configure the saturation parameters for the Langelier Saturation Index (LSI). The LSI is used for monitoring the development of corrosive or scaling tendencies in water.

The LSI is calculated from the formula:

$$LSI = pH + TF + AF + CF - 12.1$$

where:

- pH = pH sensor reading or keyboard input,
- TF = Temperature factor calculated from sensor input or keyboard input,
- AF = Alkalinity factor from data table,



- CF = Calcium Hardness factor from data table.

Alkalinity is measured with a test kit and the result entered into the Alkalinity line. Move the highlight bar to the Alkalinity line and press the right arrow. Enter the total alkalinity and press OK.

Similarly, hardness is measured with a test kit and the result entered into the Hardness line. Move the highlight bar to the Hardness line and press the right arrow. Enter the Hardness in ppm and press OK.

To access the Limits sub menu, move the highlight bar to the Limits line and press the right arrow.

pH and temperature is taken from the respective probes and the resulting LSI is displayed. The condition is also displayed based on the limits set in the Limits submenu. The conditions may be

Condition		Typical Limits
"OK"		0 to 0.30
"CORR"	Below Corrosion Limit	0
"SCALE"	Above Scaling Limit	0.3

Table 8. Corrosion / Scaling Limits

Langelier Limits Menu

The controller calculates the factors TF, AF and CF from the input for temperature (degrees), alkalinity (ppm) and hardness (ppm).

The limits for the Langelier Index re entered in the Limits submenu. To set the Scaling limits, move the highlight bar to the Scaling line and press the right arrow. The numeric sign (plus or minus) will highlight. Use the up down arrows to select the desired sign then press the right arrow. The number value will highlight, indicating that you can enter in a number. Enter the number (with decimal point) and press OK to finalize the entry.

If an alarm condition develops, the Main Display Screen alerts it with flashing characters in the bottom row.



5.7.3 Print Reports

The Print Reports menu is used to either view or download the test data that has been collected by the controller.

The range the data to be saved or viewed is from the Start Date to the End Date. To set these dates, move the highlight bar to the desired line (Start date or end date) and press the right arrow. Enter all six digits (including leading zeroes) and press the OK button.

The data is saved in memory in standard ASCII format. It can be download to the microSD memory chip by selecting the Backup Data Log and pressing the right arrow. The data will be stored on the SDchip in a file called datalog.bin. (This name may change.) The file may be renamed datalog.txt and displayed, edited and printed in text format using a text editor, such as *Windows Notepad*, *Microsoft Word*, or *Microsoft Excel*.

A maximum number of 999 sets of test data can be stored in the controller. Therefore, it is recommended to download the data periodically. Downloading the data does not erase it from the controller. To erase all data in memory, use Data Logging and select Reset.

For direct download to a computer, use the ChemComm program to connect to the controller either through the serial port or over the Ethernet connection.

5.7.4 Reset Menu

The Reset menu is accessed from the Operations Menu. Starting from the Operations menu, move the highlight bar to Reset on the Operations menu and press the right arrow.

The Reset menu has two choices: Factory Reset and Custom Reset.

The Factory Reset return the controller to the factory state: all system parameters are returned to their default values, all calibration parameters are reset, all alarms are reset, and all code numbers are removed.

Partial Reset allows resetting of individual functions, such as ORP, Sanitizer, pH, etc.

To perform a factory reset, move the highlight bar to the Factory reset line and press the right arrow. The Factory reset menu will appear. Select either Complete reset or Partial reset and press the right arrow. If Factory reset is selected a confirmation screen will appear. Select yes then press the right arrow.



To perform a Partial reset, move the highlight bar to the Partial reset line and press the right arrow. The Partial Reset menu will appear.

Move the highlight bar to the desired parameter and press the right arrow. A confirmation screen will appear, select yes or no, and press the right arrow. Press the left arrow to return to the Factory Reset menu, and once more to return to the Configuration menu.\

For each item, the reset option

1. Clears alarms and resets the alarm levels to factory default
2. Resets calibration to factory default
3. Resets run time to zero

5.7.5 Battery

The Battery screen shows the state of the internal battery. Replace the internal battery when the voltage drops below 2.5 V

5.7.6 Probe Monitor

The Probe Monitor menu is accessed from the Operations menu by moving the highlight bar to the Probe Monitor line and pressing the right arrow. The Probe Monitor menu will appear.

The Probe Monitor menu shows the data for the ORP and pH probes. To perform a test, move the highlight bar to the desired Probe Test line and press the right arrow. Press the right arrow once more to access the Alarm Options Feed Lockout menu. Press the right arrow to toggle the Feed Lockout between yes and no. Press the left arrow to return to the Probe monitor menu. Now, press the right arrow once to change the probe test from yes to no (or no to yes). Press the left arrow to return to the Operations menu.



5.8 Communications Menu

The Communications menu is accessed from the Configuration menu by moving the highlight bar to the Communications line and pressing the right arrow.

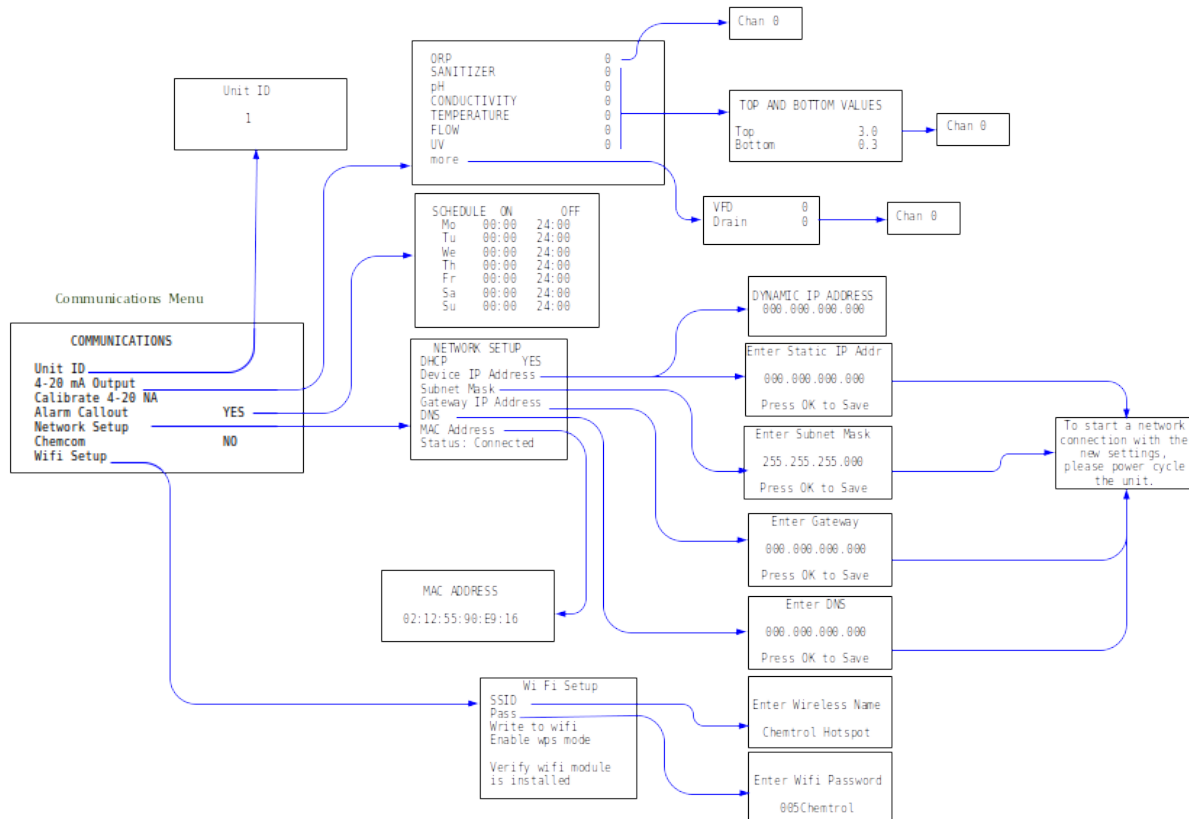

The Communications menu is used to set the Unit ID, 4-20 mA calibration, Alarm callout schedule, Network setup and Wifi setup.

Unit ID

The unit identification number is used to identify individual controllers in RS-422 multi-drop systems. If the controller is in an Ethernet system, the Unit ID must be set to 1 to interact with the Chemtrol Web.

4-20 mA Output

The 4-20 mA Output is used to scale the 4-20mA outputs. This menu is accessed by moving the highlight bar to the 4-20 mA Output line in the Communications menu and pressing the right arrow. The 4-20 mA selection menu shown below and permits selection of one of eight outputs.



Move the highlight bar to the desired output and press the right arrow. The Top and Bottom Values menu will appear. Select either the Top or Bottom line, press the right arrow and enter in the target numeric output for top (20 mA) and bottom (4 mA).

Calibrate 4-20 (Input)

The calibrate 4-20 mA inputs sets up the scaling for the 4-20mA inputs. Set the Calibrate 4-20 line in the Communications menu and press the right arrow button. The **Select 4-20 Channel** menu will appear. Select the desired channel by using the up arrow and down arrow keys. After the desired channel has been selected, press the right arrow. The Calibrate 4-20 #x menu will appear (x is the channel number). Use the highlight bar to select 20ma line or the 4ma line and press the right arrow key. Enter the numeric input that 4ma and 20 mA represents on the respective line. Press OK to finalize the value and left arrow to return to the previous menus.

5.8.1 Network Setup

The Network setup menu sets up and displays the DHCP, Device IP address, Subnet Mask, Gateway IP Address, DNS, MAC Address, and status.

DHCP

Move the highlight bar to DHCP and press enter. Select yes or no using the UP and DOWN arrow keys. Press the RIGHT ARROW to return to the previous menu.

Device IP address

Move the highlight bar to Device IP Address and press enter. If DHCP had been selected, the assigned IP address will be shown (after cycling the power). Otherwise enter the IP address as 12 digits followed by the OK key.

Subnet Mask

Move the highlight bar to Subnet Mask and press enter. Enter the mask address as 12 digits followed by the OK key.

Gateway IP Address,

Move the highlight bar to Gateway IP and press enter. Enter the mask address as 12 digits followed by the OK key.

DNS

Move the highlight bar to DNS and press enter. Enter the mask address as 12 digits followed by the OK key.



MAC Address

Move the highlight bar to MAC Address and press enter. The MAC address is shown. It cannot be changed.

Status

The Status line shows the status of the Network connection. When connectrd it also shows the numeric ID of the Chemtrol webserver.

WiFi Setup

The WiFi menu setup the WiFi Connection to the controller. The controller must have the WiFi option installed.

SSID

The controller will show the default SSID with the cursor at the left end. Enter each letter of the new SSID using the UP and DOWN ARROWS then move to the next character position using the RIGHT ARROW. When completed, press OK.

Pass

The controller will show the default Password with the cursor at the left end. Enter each letter of the new password using the UP and DOWN ARROWS then move to the next character position using the RIGHT ARROW. When completed, press OK.

Write to wifi

After the SSID and Pass have been setup, place the highlight bar on the Write to wifi line and press the RIGHT ARROW. The SSID and Pass will be written to the WiFi module and the WiFi communications will be enabled.



5.9 ORP Menu

The ORP menu is used to set up the ORP sensor

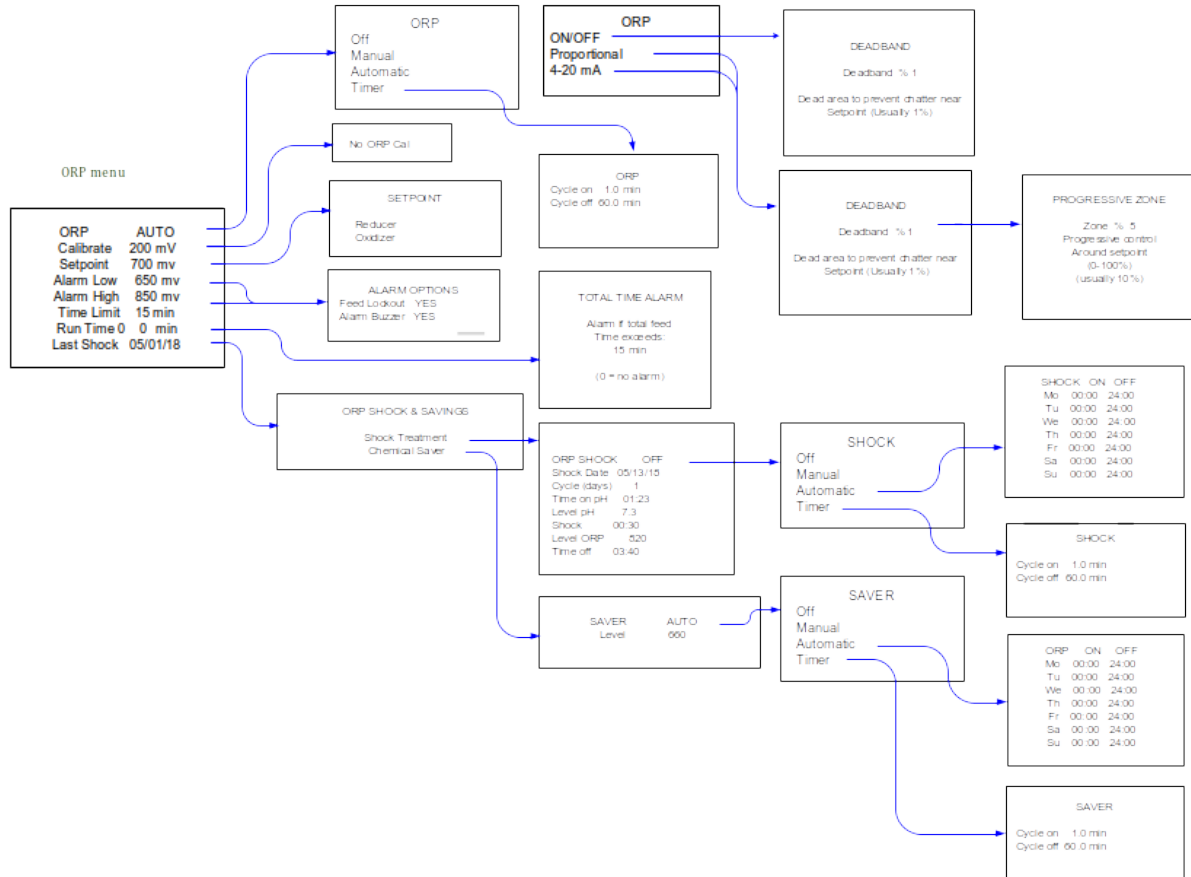

5.9.1 Calibrate

This line displays the current reading of the ORP sensor in mV. There is no calibration menu for ORP since there are no readily available calibration solutions in the range of operation for water treatment.

5.9.2 Time Limit

The TIME LIMIT sets the maximum allowed time (in minutes) for continuous oxidizer feed. This acts as a safety feature to prevent overfeeding in case of malfunction of the chemical feeder or as an alarm if the feed tank runs empty. The standard (default) value for ORP is 15 minutes.



When in alarm, Time Limit is reset by highlighting the value and pressing OK. To defeat the safety timer, enter zero (0).

5.9.3 Run Time

The RUN TIME line displays two separate values: the amount of running time in minutes for each current activation event and the total run time since last reset to zero.

To reset the cumulative run time, enter zero in the far right column. To reset only the current run time, highlight Time Limit value and press OK. The Total Time Alarm will appear.

5.9.4 Total Time Alarm

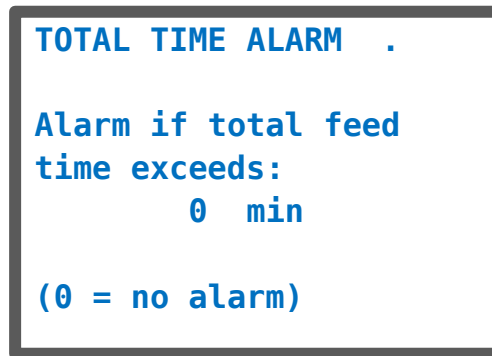

Figure 64. ORP Total Time Alarm

The ORP Total Feed Time menu is used to show the feed time from a chemical tank since last reset to zero. Knowing the pump feed rate, it can be used to monitor the emptying of the tank and set a low-level alarm. This feature is particularly useful for remote monitoring of the chemical tanks.



5.10 SANITIZER MENU OPTION

The SANITIZER function is used to monitor the concentration of chlorine (or bromine) using either Free Chlorine sensor input probe or values calculated from ORP and pH inputs

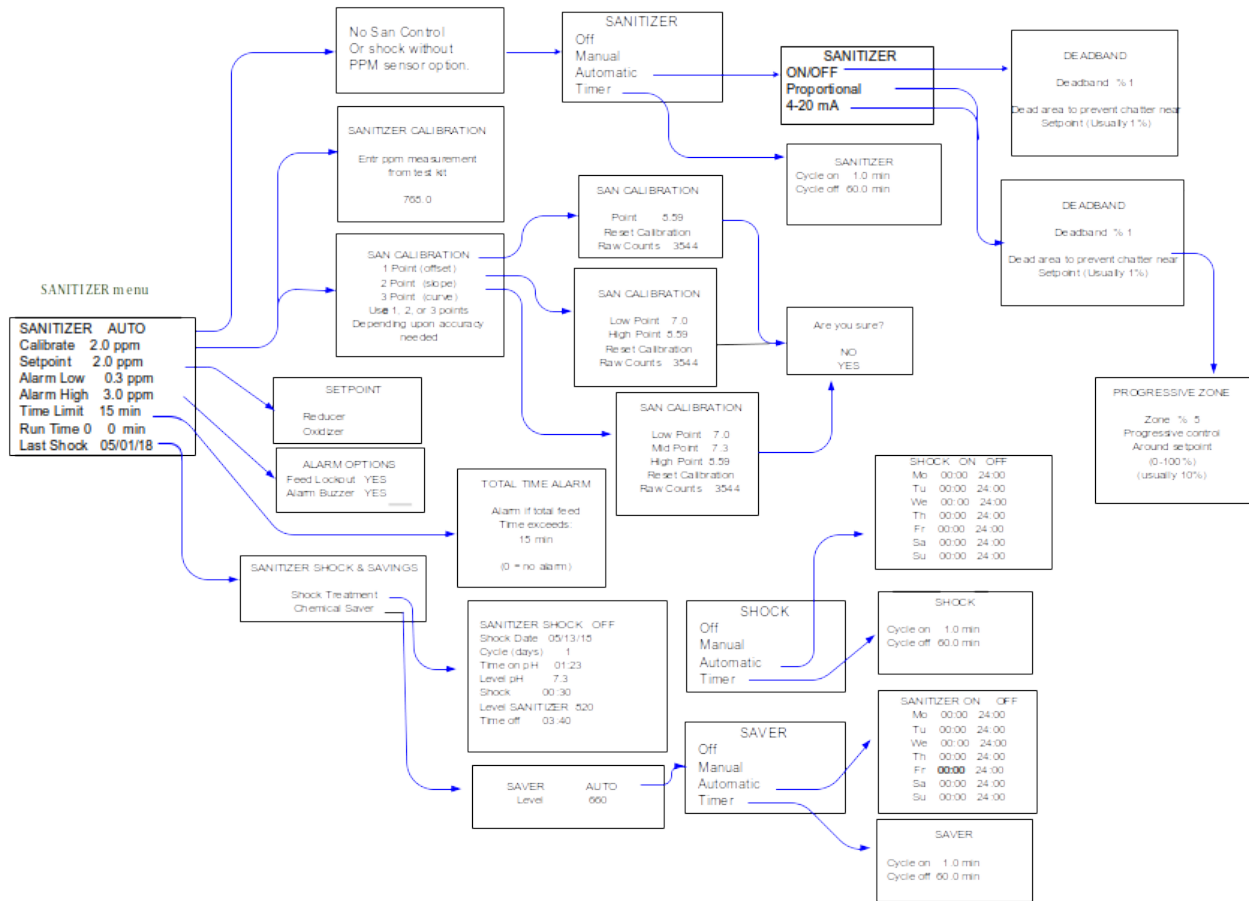

Sanitizer level may also be calculated using a *CHEMTROL®* proprietary algorithm. The algorithm is most accurate with clean water and can be affected by the presence of organic and inorganic contaminants including cyanuric acid. In general, clean water shows higher ORP values at lower ppm values. Thus, as the contaminant level increases, an increased level of sanitizer (ppm) is required to obtain the same ORP level. If it becomes excessive, shock treatment or water replacement is required.

This option sets up the control parameters for the 4-20 mA output. A deadband menu followed by a progressive zone menus are presented. Here the deadband and progressive zone margin are setup to enhance the stability and accuracy of the 4-20 mA output.

NOTE: Before recalibration, always do a partial reset of PPM readings using the Operations Menu.



For a pH of 7.5, the calibration algorithm assumes a baseline default value of 635 mV of ORP for 0 ppm.

For heavily contaminated water, the baseline can be readjusted to lower values. For instance, if the controller readings are too low by 1 to 2 ppm, a baseline value of 600 mV gives better results. For more than 2 ppm, use 575 mV.



5.11 ppmT Menu

The ppmT or Total chlorine menu is used to calibrate the Total Chlorine sensor. A one, two or three point calibration may be selected.

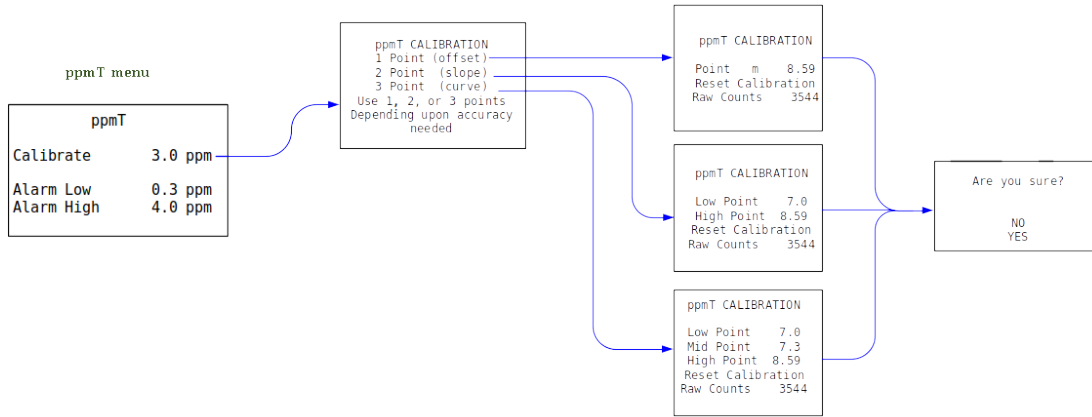

5.12 ppmA Menu

The ppmA or Active chlorine is used to both measure the active chlorine present and to control the chemical feed of the sanitizer being used, to set alarm levels, set the type of control used (manual, automatic, or proportional), and set other parameters.

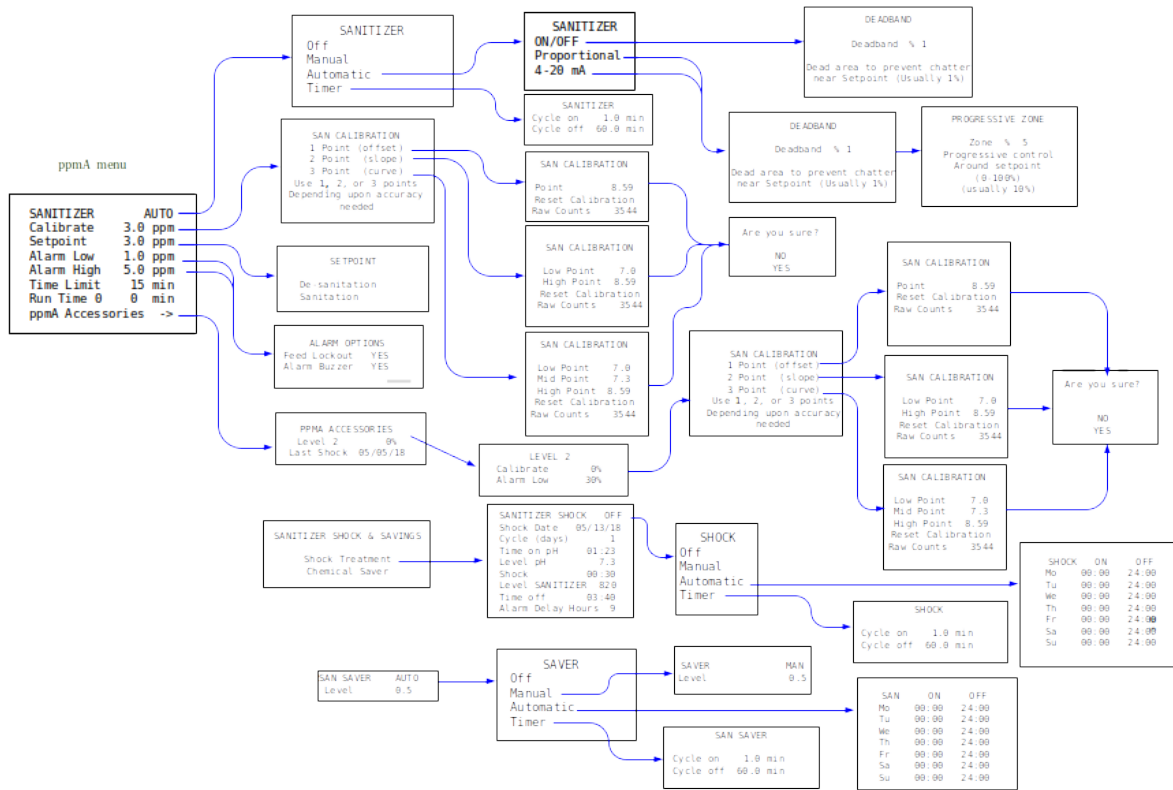

5.13 pH MENU

The pH Menu screen is used to access all the pH submenus for Control Mode, sensor calibration, set point and alarm settings.

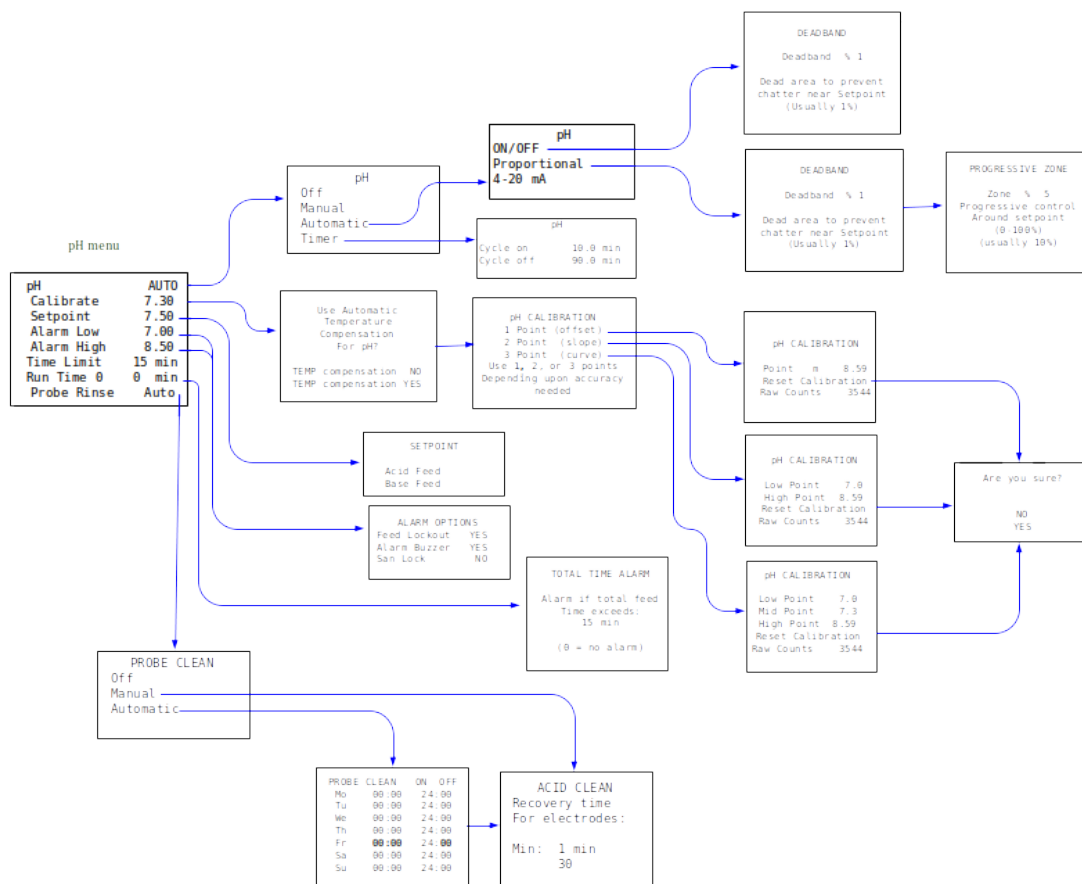

It also displays the actual run time for individual feed events and the cumulative run time since last reset to zero.

The pH function is used to monitor the acid –base status of the water.

The pH menus are accessed from the main menu (Section 5.3) by moving the highlight bar to the third row (pH) and pressing the RIGHT ARROW. If the pH is not setup as YES, i. e. present, the pH row will read NA and the pH menus will be unavailable.



5.14 TDS / Conductivity Menu (Total Dissolved Solids / Conductivity)

The TDS/COND sensor is used to monitor and control a TDS/COND, like chlorine or bromine, or a true oxidizer like ozone. The TDS/Cond menu shown in Figure 61

The Conductivity sensor monitors the concentration of Total Dissolved Solids (TDS) in the water. The conductivity of the water in microsiemens per centimeter ($\mu\text{S}/\text{cm}$) may be converted into ppm or mg/l of TDS with a conversion factor that depends on the type of ionic species that are present in the water. Normally, a value of 0.5 is used for water solutions containing different species of carbonate and chloride ions.

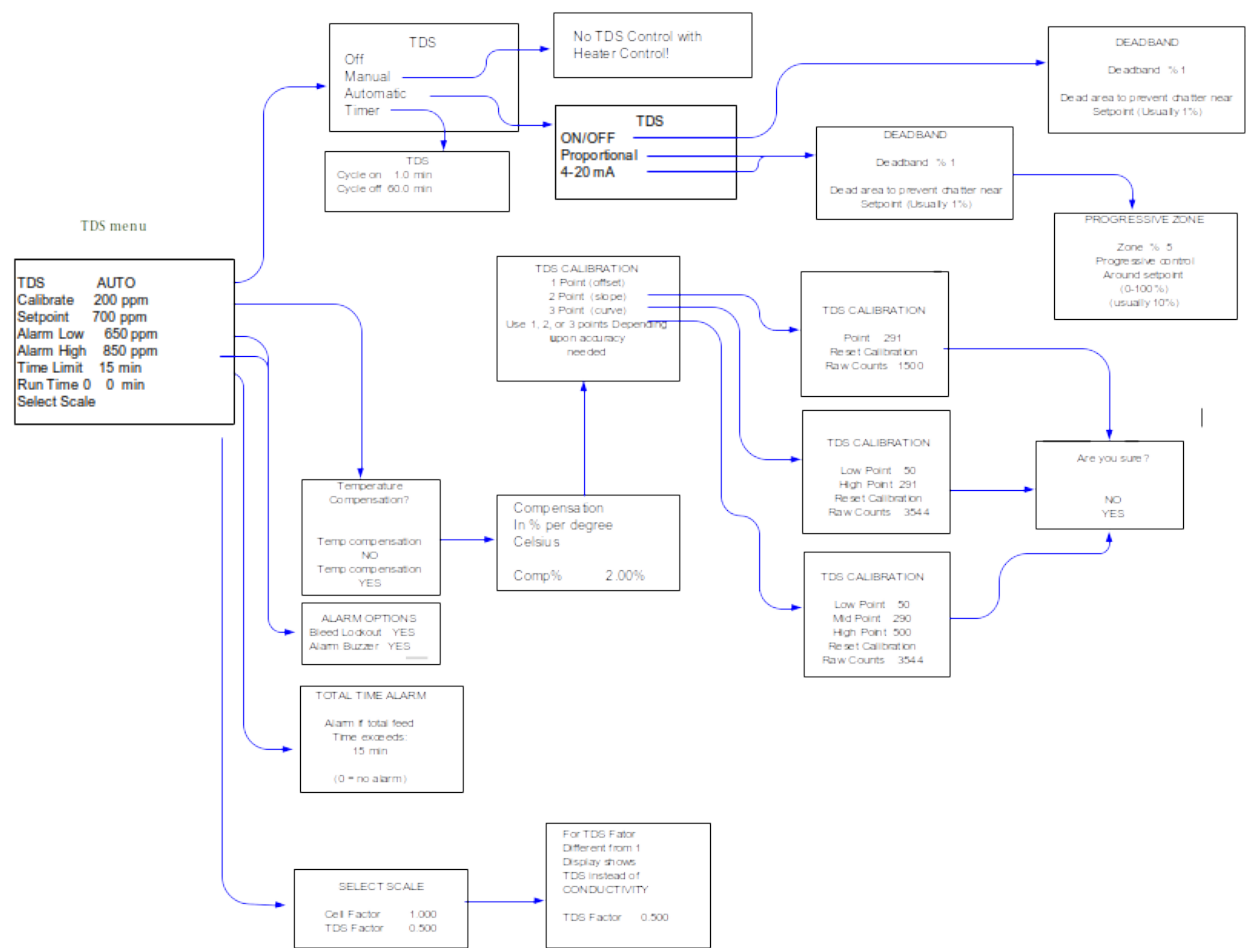

Figure 65. TDS Menu



Conductivity or TDS can be controlled in two different directions:

- downward (decrease) to bleed water when the TDS level gets too high, or
- upward (increase) to add a salt brine solution for an electrolytic generator when the TDS level gets too low.

IMPORTANT NOTE:

Conductivity control is available only when Probe Clean control is OFF. It activates the relay labeled "Acid Clean" located on the Power board.

Depending on the application, it may be customary to control either conductivity or TDS. Both displays are available in the two systems, as shown on the sample screens.

To change the displays from conductivity to TDS, enter a TDS factor different from 1 in the Select Scale menu (more below) menu. If the TDS Factor is 1, the display shows Conductivity (COND) in $\mu\text{S}/\text{cm}$. If different from 1, it shows TDS in ppm or mg/l.

The TDS Menu screen is used to access all the TDS submenus for Control Mode, sensor calibration, set point and alarm settings. It also displays the actual run time for individual feed events and the cumulative run time since last reset to zero.

The TDS menus are accessed from the main menu 1 by moving the highlight bar to the fourth row (TDS or COND) and pressing the RIGHT ARROW. This will bring up the TDS/COND menu. If the TDS is not setup as YES in the system configuration i. e. not present, the TDS/COND row will read NA and the TDS/COND menus will be unavailable. The menus shown will be for TDS where COND would be for conductivity measurements.



5.15 TEMPERATURE CONTROL

The Temperature Menu, or Heater Menu, is used to control the operation of the heater with the temperature sensor. All displays can be shown in either degrees Fahrenheit or Celsius.

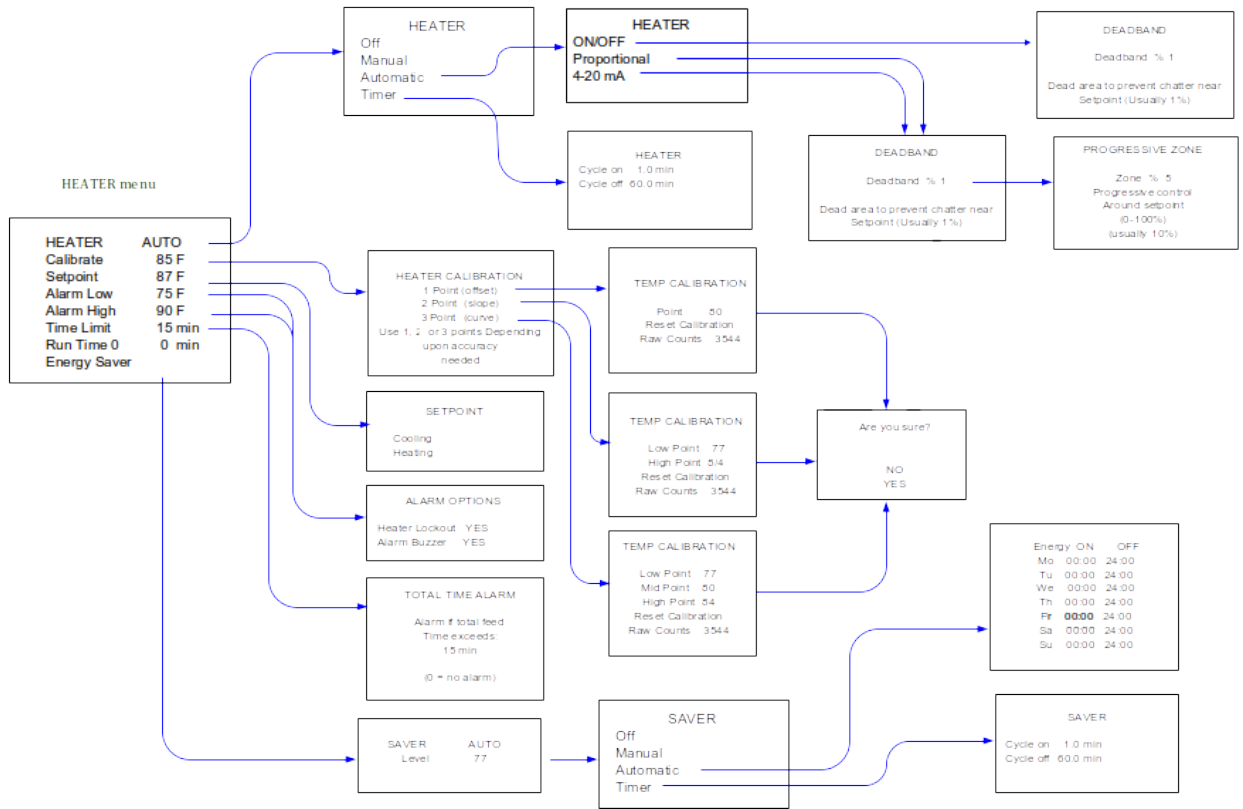

5.16 Pump Menu

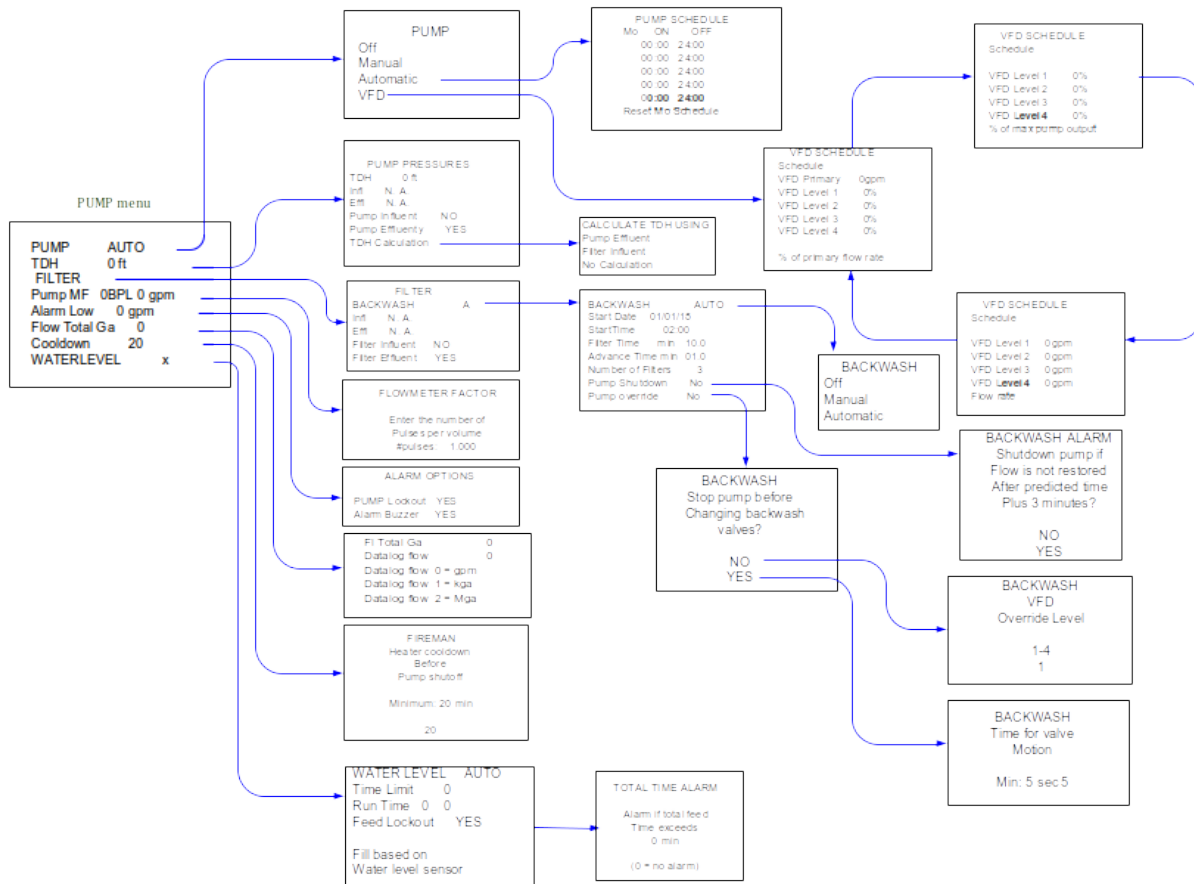

The flow meter factor is calibrated by entering the K-factor provided by the sensor manufacturer. These values correspond to the number of pulses per unit of volume in gallons or liters, which are given by the sensor manufacturer.



5.17 Backwash Auto Menu

The unit contains several combinations for determining backwash initiation.

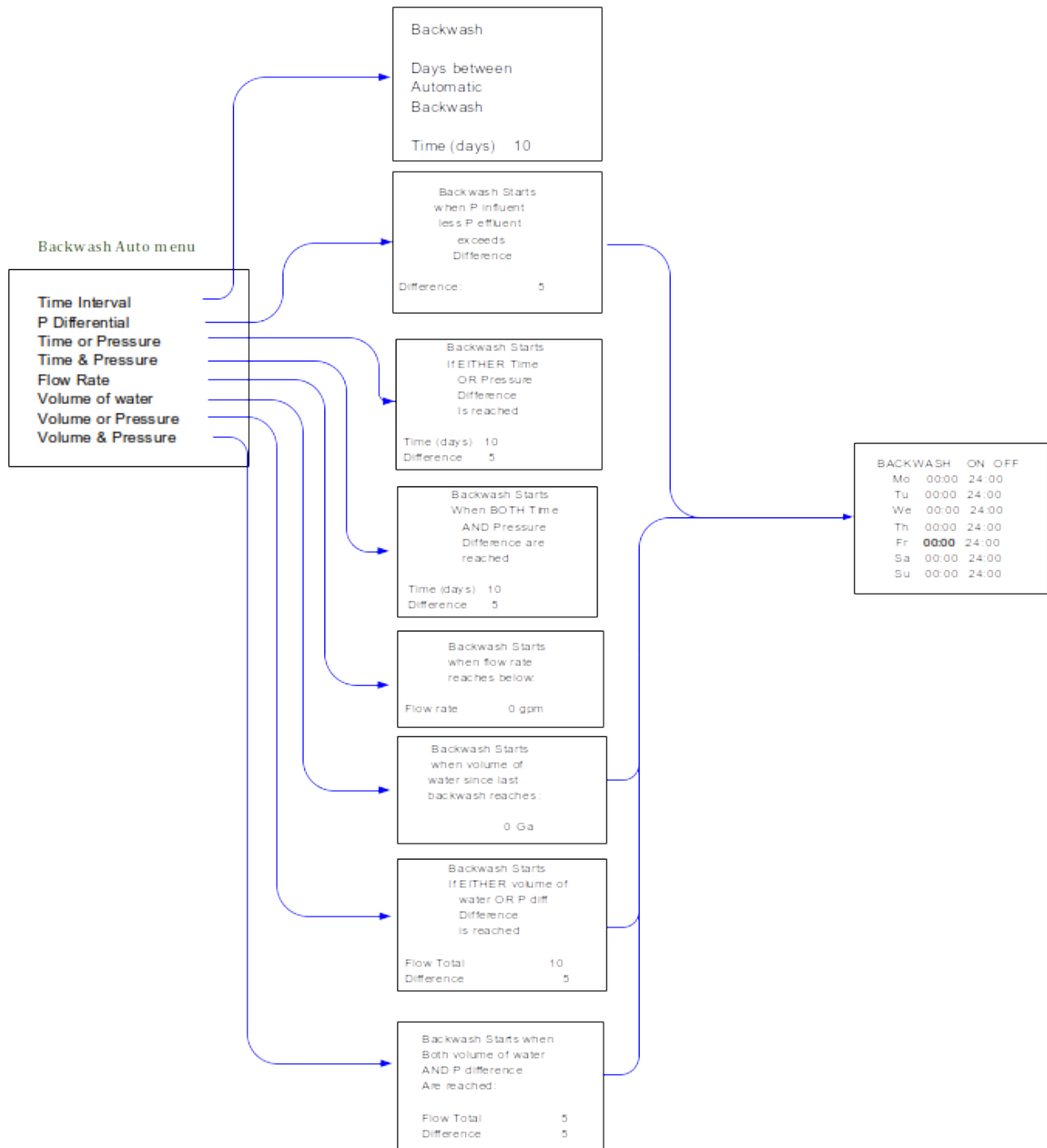

5.18 PROPORTIONAL CONTROL

The Proportional Control mode is recommended only for small pools and spas to prevent overfeeding from oversized feeders. In this mode, the outlet relay is turned ON and OFF at a rate that decreases as the setpoint is neared. The rate goes down from 100% ON in a 100-second CYCLE TIME at the edge of the Progressive Zone to 0% at the setpoint (Figure 66)

Proportional control operates only within the defined Progressive Zone. Outside the zone, control reverts to standard ON/OFF mode.

The wider the Progressive Zone is, the more slowly and precisely the controller will return to the setpoint. As the width of the Progressive Zone is decreased, the reaction becomes faster and faster until eventually, one gets near the conditions of ON/OFF control.

It should be noted that longer time limits may be required to account for the slower effective feed rates.

In the special option for 4-20 mA Control Mode, the controller sends an electronic signal output from 4 to 20 mA that is proportional to the distance from the setpoint. A 4 mA output corresponds to 0% feed rate, 12 mA to 50% and 20 mA corresponds to 100%. The values of the 0 and 100% limits are adjustable for each function.



Figure 66. Proportional Feed Rate



5.19 CALIBRATION

5.19.1 One-Point Calibration

When using 1-Point calibration, the conversion curve for the sensor readings is a straight line. The slope is a default value that is built in the program.

1-Point calibration should be satisfactory for most applications. The operator places the sensor in a single water sample and tests it with an appropriate test kit. The value obtained is then entered on the calibration screen as the new display value.

The controller uses the calibration value that has been entered by the operator to calculate the origin “a” of the representative linear equation:

$$\text{DISPLAY} = a + \text{SLOPE} * \text{INPUT}$$

5.19.2 Two-Point Calibration

With 2-Point calibration, the operator needs to use two different solutions with values that are spaced widely enough to show significant differences in the slope of the calibration curve.

The controller uses these values to calculate the origin “a” and slope “b” in the equation:

$$\text{DISPLAY} = a + b * \text{INPUT}$$

5.19.3 Three-Point Calibration

With 3-Point calibration, the straight line is replaced by a second-degree polynomial curve. The operator needs three calibration solutions with values that are sufficiently spaced apart to show differences in the curvature of the polynomial.

The controller uses these three values to calculate the origin “a”, slope “b” and curvature “c” in the equation:

$$\text{DISPLAY} = a + b * \text{INPUT} + c * \text{INPUT} * \text{INPUT}$$



Glossary

The **Shock Treatment** program is used to destroy harmful elements, such as chloramines, germs and algae, by raising the oxidizer or sanitizer level on a specified schedule. This can be done either with the ORP function menu (Shock Treatment) or with the Sanitizer function menu (SUPERCHLORINATION), depending on which activation outlet is used.

The **Deshock** program can be used after the Shocking program to return the concentration levels back to normal values.

The **Chemical Savings** program is used to save chemicals by reducing the treatment level when the facility is not in use, such as at nighttime or on weekends.



6 STARTUP

6.1 Controller Startup

6.1.1 Configuration Menu

Upon startup, verify the initial setup through the CONFIGURATION Menu and adjust the values as required. This includes adjusting the clock for different time zones and selecting the proper language and units system.

6.1.2 Alarm Buzzer

The Audible Alarm option is normally turned off until the sensors are installed. Use to turn it on for normal operation.

6.1.3 Bypass Line

By default, the Bypass Line Option is factory-set to YES to prevent accidental feeding when there is no water flow in the bypass line. To turn it off, set the Option to NO.

6.1.4 Battery Check

Check the condition of the Backup Battery. It prevents the loss of memory data in case of power shutdown. The voltage of the battery can be seen through the CONFIGURATION / BATTERY

If the battery voltage is less than 2.5V, the battery should be replaced with a 3V-lithium battery, Panasonic CR2330 or equivalent.

6.1.5 PPM Board Initialization

The PC board for the PPM sensor on the PC2100 must be initialized prior to calibration of the PPM sensor itself.

Turn the controller on and wait at least 30 minutes to allow the sensor to charge. Read the **PPM SANITIZER** display on the controller.

6.2 Chemical Control

6.2.1 Initial Activation of Sensors

For a new pool or spa, it is recommended to wait for a week or two after filtration is started before installing the sensors. This will prevent damage to the sensors until all the dirt and debris have been filtered out of the water. When ready to start the controller, install the sensors in the recirculation line and run the recirculation pump for 30 to 60 minutes or until the readings of the sensors stabilize.



6.2.2 Bypass Line Test

If there is a bypass line, open the sampling tap on the bypass line and adjust the two shutoff valves until there is a smooth flow of water coming out of the tap (no suction or excessive pressure).

6.2.3 Water Chemistry Adjustment

Before starting automatic control, the water chemistry should be adjusted to near the recommended values of 7.5 for pH and about 1 ppm for chlorine (2 ppm for bromine). The chemicals can be added manually or with the controller set on Manual Mode.

Also, verify that the cyanuric acid level is below 40 ppm, the Alkalinity between 80-120 ppm and the Total Dissolved Solids (TDS) level below 1,500 ppm. If either one of these limits is exceeded, the water is contaminated. It should be replaced with as much fresh water as needed.

6.2.4 Water Sampling

Proper water sampling is essential for accurate calibration of the pH and ORP sensors. The preferred method is to sample the water as close as possible to the location of the sensors, usually on the bypass line. The bypass line should be therefore equipped with a water-sampling tap, which can be a ball valve.

Because of the instability of chlorine, particularly under sunlight, samples taken near the surface of the water can give false results.

6.2.5 pH Calibration

NOTE:

Always calibrate the pH sensor first, i.e. before the sanitizer.

Test the pH of the water at least twice with a fresh solution of a standard Phenol Red test kit, or until you get consistent readings.



The pH of the water should be near 7.4 to 7.5. If not, adjust it manually or with manual feed control:

If the pH is below 7.0:

- **CAUTION: CORROSIVE CONDITION.** Add a base (Soda Ash, Caustic Soda NaOH, pH PLUS, pH UP, etc.) to raise it as soon as possible.

If the pH is above 8.0:

- **CAUTION: SCALING CONDITION.** Add an acid (Muriatic Acid, Hypochloric Acid HCl, CO₂, Sodium Bisulfate, pH MINUS, pH DOWN, etc.) to lower it.

If the test kit value differs from the value shown on the controller display, select the pH Calibration and enter the value indicated by the test kit, using the 1-Point Calibration option.

For more accurate calibration with two or three points, repeat the same process at two or three different pH values using calibrated standard solutions of appropriate values. Most common values are for pH 4.0, 7.0 and 10.0.

6.2.5.1 pH Feed (Acid or Base)

The *CHEMTROL*® PC has two pH control relays, one for Acid feed and one for Base feed. Acid Feed is activated when the pH is above the setpoint and Base Feed when it is below the setpoint.

In most cases, only one type of chemical is required, i.e. either acid or base, depending mostly on the type of sanitizer used. Make sure to connect the acid or base chemical feeder to the proper outlet on the Power Board

6.2.5.2 pH Setpoint

The default value for the pH setpoint is 7.5. It can be modified at any time through the pH Menu.



6.2.5.3 ORP Calibration

The ORP sensor is direct reading and does not require calibration.

6.2.6 ORP Setpoint

The default value for the ORP setpoint is 700 mV. It can be modified at any time through the ORP Setpoint Submenu

The controller will automatically activate the chlorinator, brominator or ozonator whenever the reading is below the ORP deadband. It will stop automatically as soon as the reading is above the ORP setpoint.

6.2.7 Sanitizer Calibration

NOTE:

Make sure to adjust the pH between 7.4 to 7.5 before calibration of the sanitizer.

Test the water with a DPD or FACTS test kit for Free Chlorine or Bromine. Do not use an OTO (Total Chlorine) test kit. Make sure that the test solution is fresh and test at least twice or until you get consistent readings.

The water should test close to 1.5 ppm for chlorine or 3.0 PPM for bromine.

- If the water tests below these values:
 - Add sanitizer as needed to bring the PPM reading to a proper value.

- If the water tests above 3.0 ppm for chlorine or 8.0 ppm for bromine:
 - wait until the level is reduced to below these values,
 - add a reducing agent (Sodium Thiosulfate), or
 - replace part or all of the water.

Select the Sanitizer Calibration and enter the value indicated by the test kit.

6.2.8 Time Limits

The Time Limits for each outlet should be set for the length of time that can be safely tolerated for chemical overfeeding - in case of equipment malfunction or operator error. This time limit varies with each installation, based on the size of the installation (gallons of water) and the feed rate of the chemical feeders.



If needed, see your *CHEMTROL*® PC Qualified Dealer for assistance.

6.2.9 Shock Treatment

It is recommended to wait several weeks before using the automatic super-oxidation or super-chlorination cycle, or until all the other operating functions of the controller have been properly tested.

6.2.10 Chemical Saver

The Chemical Saver program is used to lower the oxidizer or sanitizer level when there is little use, such as at night or on weekends.

Chlorination should be prevented completely whenever a pool cover is in place.

It is also recommended to stop sanitizer feed for pools where there is insufficient mixing of water at night - due to the lack of water mixing by swimmers or convection currents. This can lead to stratification of the chemicals in the water and eventual over-chlorination.

6.2.11 Water Saturation

The *CHEMTROL*® PC features automatic calculation of the Langelier Saturation Index.

It is recommended to check the water saturation as soon as possible after installation to prevent damage to the equipment through corrosion or scaling. This should be done immediately after calibration of the pH and temperature sensors, using a reliable test kit to obtain the alkalinity and calcium hardness values.



7 CHAPTER VI - MAINTENANCE

7.1 CONTROLLER MAINTENANCE

7.1.1 Regular Maintenance

The *CHEMTROL*® PC controller requires little maintenance besides cleaning of the sensors and replacement of the battery, if needed, after a long shutdown.

How often the sensors require cleaning depends on the quality and flow of water. Use the Acid Test below to check the ORP and pH sensors. For commercial and public pools or spas, it is recommended to schedule preventive cleaning programs on a weekly or monthly basis.

7.2 The Acid Test

The Acid Test can be used to check the ORP, pH sensors and the bypass line.

Carefully add a small amount ($\frac{1}{2}$ cup or less for a public pool, a small capful for a spa) of hydrochloric (muriatic) acid HCl in the intake side of the recirculation line, upstream of the sensors, and observe the ORP and pH readings on the Main Display. After a few minutes, the pH reading should go down and the ORP reading up. After several minutes, both readings should return to their original values.

7.2.1 Sensor Cleaning

7.2.1.1 PPM Sensor Cleaning

DO NOT CLEAN the PPM sensor or the membrane. May cause irreparable damage.

7.2.1.2 ORP and pH Sensor Cleaning

The sensors stop reading when they become coated with oil, calcium or dirt. To clean the ORP or pH sensors, carefully remove it from the compression fitting and clean the tip in a liquid soap solution (such as Joy, Palmolive, etc.). If it still does not work, dip it again for 5 to 10 seconds in muriatic acid (hydrochloric acid HCl). Rinse in clean water and reinsert it in the fitting.

7.2.1.3 Conductivity Sensor Cleaning

The electrodes of the TDS/Conductivity Sensor can be cleaned with a mild abrasive (brush or sandpaper) to remove non-conducting deposits.

7.2.1.4 PPM Sensor Storage

Store the PPM sensor dry and protected.

7.2.1.5 ORP and pH Sensor Storage

- store at room temperature,



- keep the protective cap on the sensor filled with water to keep the tip moist. Check periodically that there is always some water inside the cap,
- store the sensors with the tips down to prevent the air bubble from migrating toward the junction,
- soak the sensor in a salt solution if stored over 3 months.

7.2.2 Sensor Winterizing

During cold weather, all sensors must be protected from freezing.

7.2.3 Battery Replacement

The memory battery is located in the upper left corner of the Mother Board. It keeps the settings for configuration, operation and calibration in memory - if the power supply is shut down. A low battery condition does not affect the operation of the controller as long as the main power is on.

To check the voltage of the battery, go to Configuration/Operations/Battery to display .

If the battery shows a voltage below 2.5 V, it should be replaced with a 3V lithium battery, Panasonic CR 2330 or equivalent.

To replace the battery, turn off the power to the controller, slide out the old battery and insert the new one, making sure to set it in with the positive (+) side up.

After full power shutdown, the controller reverts to the original factory default settings. You must re-enter your own settings if they are different.

7.2.4 Software Upgrade

Software is updated on an as required basis. Updates may be needed, for example, if additional sensors are added or if there are special or unusual requirements. Updates are provided on a micro SD card. Place the micro SD card in the control and turn on the power. The update occurs automatically.



7.3 Final Review and Recommendations

It is recommended to check the calibration of the controller at the same time of the day, preferably in the morning after a couple of hours of operation, but before full sun. This is especially important for pools stabilized with cyanuric acid as the effects of sunlight on chlorine activity are not detected by the test kits and may lead to false and unnecessary readjustments.

The pool operator should become familiar with ORP technology (see below) and learn to trust the information it provides rather than less reliable test kits.

7.3.1 pH Control

The importance of proper pH control cannot be over emphasized, as it affects every aspect of water chemistry.

For pools and spas, the recommended pH set point is between 7.4 and 7.8. Below 7.4, the water becomes increasingly corrosive and causes stains, etching of plaster and eye irritation. Above 7.5, the efficiency of the sanitizer decreases rapidly and the water becomes too alkaline - which causes cloudiness, stains and scaling.

pH control is also affected by Total Alkalinity (TA). If it is too high (above 150 ppm), pH response is slow and requires more acid or base feed. If it is too low (under 100 ppm), pH control becomes very sensitive.

For best results, it is strongly recommended to have the same operator in charge of water maintenance and testing, as different people read test kits differently.

Because of the Time Lag for mixing of the chemicals in the water, there is always a fluctuation (0.1 to 0.2 pH units) above or below the setpoint, depending on the chemical feed rate.

If the pH tends to overshoot the set point, the Control Mode should be set to Proportional. Alternatively, the feed rate of the acid or soda feed pump can be reduced or a more dilute solution can be used (especially in a small body of water, like a spa). **DO NOT CHANGE THE SETPOINT.**



In an ACID FEED system, if the pH display consistently reads too high (not enough acid), the feed rate of the acid feed pump should be increased, or a stronger solution should be used. DO NOT CHANGE THE SETPOINT.

In a SODA FEED system, if the pH display consistently reads too low (not enough soda), the feed rate of the soda feed pump should be increased, or a stronger solution should be used. DO NOT CHANGE THE SETPOINT.

7.3.2 ORP and Sanitizer Control

The recommended control level is 1.5 to 2.0 ppm of chlorine or 3.0 to 4.0 ppm of bromine at a pH of 7.5. To be sure of proper sanitation, the ORP should always be above 650 mV.

Even if using additional purification systems, such as ozone, UV systems or metal ion systems, **THE ORP READING MUST ALWAYS BE MAINTAINED ABOVE 650 mV.**

Because of the Time Lag between injection of chemicals, mixing in pool water, and return to the sensors, it is normal to see a variation of a few tenths of a PPM around the setpoint, depending on the feed rate of the chlorinator or brominator.

If the display shows too much overshoot, the Control Mode should be set to Proportional to reduce the feed rate. DO NOT CHANGE THE SETPOINT.

If the display consistently reads below the set point, reduce the width of the Progressive Zone or set the control mode to ON/OFF to increase the feed rate. DO NOT CHANGE THE SETPOINT.

The sensor reads ORP (Oxidation-Reduction Potential) which is closely related to the FAST ACTING FREE CHLORINE (HOCl), the most effective sanitizer. The DPD and FACTS test kits - and most other controllers - however read only the combination of FAST ACTING and SLOW ACTING FREE CHLORINE (HOCl and OCl⁻). This is not very meaningful because the slow acting form of chlorine is about 80 to 100 times slower than HOCl in killing bacteria.

With proper automatic pH control, the reading on the sanitizer display is very close to test kit readings. If the pH varies too much however, the *CHEMTROL*® controller will show the variations in HOCl - which are not shown by normal test kits. It is normal therefore to see small differences in readings between display and test kit if the pH varies.



If the ORP reading is maintained above the recommended minimum of 650 to 750 mV, the water should be free of germs and bacteria. Below 650 mV, germs and bacteria will develop rapidly.

ORP readings are closely tied to the concentration of Fast Acting Free Chlorine (HOCl), which is affected by pH and by the cyanuric acid level. If the pH and/or cyanuric acid level is too high, the ORP will be reduced even with high levels of chlorine.

With stabilized forms of chlorine (dichlor powder or trichlor tablets), it is important to test the cyanuric acid level in the water regularly and to dump or replace part of the water when it gets over 40 ppm - especially in spas.

If other purification systems are used (ozone, UV or metal ions systems), it is very important to maintain the proper ORP level at all times with chlorine or bromine residuals.

NOTE:

Make sure to shut off the Bypass Line when adding sequestering agents as they will coat the platinum ring of the ORP sensor, resulting in false readings

7.3.3 Limit Timers (Overfeed Safety)

The Time Limit settings are designed to disable the feeders or other equipment in case of equipment failure or operator error such as:

- sensor or electronics failure,
- chemical feeder malfunction,
- improper valving of the recirculation system,
- manual override of automatic control by untrained or unauthorized personnel,
- depletion of chemical supply.

In normal operation, the chemical feeders are activated only for a short period - that is until the chemical level in the water has returned to the proper value. As soon as the chemical feeder is activated, the safety timer is turned on. Normally, feeding stops before the time limit is reached. The timer then resets to zero and waits for the next activation cycle.



However, if feeding continues over the preset time, the timer immediately stops the feeder and activates the overfeed alarm. After correcting the malfunction, reset the timer by momentarily setting the limit to 0

7.3.4 Timer Settings

To select the proper setting for each safety timer, the operator must take into consideration the size of the pool or spa and the feed rate of the chemical feeder. In case of doubt, make sure to consult a qualified *CHEMTROL*® representative or call the factory.

NOTE 1:

The chemical feeders should be properly sized for the installation so that they do not have to feed continuously for more than 3 hours - even during peak usage periods.

NOTE 2:

Once tripped, the safety timer has to be reset manually by the operator after investigation and correction of the malfunction



7.4 PERIODIC MAINTENANCE

7.4.1 Water Testing

1. Test the water with a reliable and fresh test kit daily or as often as required by the local health department.
2. Adjust the reading of the display if needed.
3. If the PPM or pH readings are out-of-range:
 - a. Investigate and correct the cause of the problem immediately,
 - b. Readjust the water manually if needed and recalibrate the displays.
4. If the displays cannot be recalibrated after adjustment of the water chemistry, clean the sensor tips and recalibrate the displays.
5. If the displays still cannot be calibrated, see the troubleshooting section.

7.4.2 Shock Treatment

Even when maintaining the proper chlorine residual level with Chemical Automation, it is recommended to shock or super-chlorinate the water periodically for the following reasons:

1. To prevent algae growth resulting from genetic adaptation of algae species to chlorine, i.e. becoming chlorine resistant.
2. In the event that the chlorine level is allowed to fall below the normal level, even for a short period (due to exhaustion of chemicals or technical malfunction), there can be formation of chloramines. These can be destroyed only by breakpoint super-chlorination.

WARNING:

If the chloramine concentration exceeds 0.2 PPM (mg/l), it is recommended to superchlorinate at 10 times the combined chlorine level.

The shock treatment program can be set up either through the ORP Menu, using the proper daily or weekly program schedule.



7.4.3 Precautions

1. During super-chlorination, the Limit Safety Timer is disabled.
2. A SHOCK treatment warning is displayed on the Display Screen when activated.
3. During backwash the controller stays on if setup for automatic backwash. The chemistry checks go into standby.
4. The out-of-range alarms stay on as long as the oxidizer or sanitizer levels are above the high limits or below the low limits.

**ALWAYS MAKE SURE TO TURN OFF THE
CONTROLLER AND SHUT OFF THE
BYPASS LINE WHEN DOING GENERAL
POOL MAINTENANCE.**

7.5



8 TROUBLESHOOTING

<i>PROBLEMS</i>	<i>SOLUTIONS</i>
1. NO DISPLAY.	1a. Check power to system. 1b. Check On/Off Switch on right side of cabinet. 1b. Check Voltage Selector Switch in upper section of Power Board. 1c. Verify proper input voltage 110V or 230V. 1d. Check Fuse F2 on Power Board. If blown, replace with AGC1 fast blow fuse..
2. FAINT OR DARK DISPLAY	2a. Adjust contrast with Display <ul style="list-style-type: none"> a. R85 on the CH 2100 board b. R 85 on the 604 board
3. ERRATIC DISPLAY.	3a. Turn Power Switch off for 10 seconds and back on. 3b. Check power cable contacts. 3c. Check power strip connecting Mother Board and Power Board. 3d. Check the SD card for proper seating..



<p>4. NO CHEMICAL FEED NO HEATER ACTIVATION NO VALVE ACTIVATION</p>	<p>4a. Check flashing line in Main Display Screen. Highlight flashing line with UP or DOWN arrow. Press RIGHT arrow to enter submenu. Check flashing line in Submenu.</p> <p>4b. If LOW or HIGH ALARM is flashing: Adjust water chemistry manually. Press RIGHT arrow to change alarm limits. Set Feed Lockout to Off (CAUTION !!!).</p> <p>4c. If TIME LIMIT line is flashing: Increase chemical feeder rate. Increase Limit Timer setting. Reset Time Limit with AUTO setting.</p> <p>4d. If BYPASS LINE is flashing on Main Display: Check water flow in bypass line. Check Safety Flow Switch in bypass line. Set Bypass Line to Off in Operations Submenu (CAUTION !!!).</p> <p>4e. Set Feed Mode to MANUAL. Feed Indicator on Main Display should turn on.</p> <p>4f. Check Relay Fuses on Power Board. ORP: Fuses F4 and F5 Sanitizer:Fuses F10and F11 pH: Fuses F8 and F9 Heater: Fuses F4 and F5 TDS: Fuses F4 and F5 Filters: Fuses F4 and F5</p>
<p>5. CANNOT CALIBRATE</p>	<p>NOTE: The ORP needs to be above 650 mV for Sanitizer calibration.</p> <p>5a. Check water balance and adjust if needed.</p> <p>5b. Clean faulty sensor as indicated.</p> <p>5c. Check sensor connections.</p> <p>5d. Check sensor with the PORTAPROBE™.</p> <p>5e. Test electronics with the PORTAPROBE™.</p>



<p>6. CHLORINE OR pH OVERFEED</p>	<p>6a. Clean and test the faulty sensor. 6b. Check and adjust the calibration. 6c. Check and adjust the setpoint. 6d. Check the relay. 6e. Check the chemical feeder for leaks. 6f. Reduce feed rate or dilute the solution. 6g. Check the Superchlorination Program. 6h. Adjust proportional, increase progressive zone.</p>
<p>7. IMPROPER READINGS</p>	<p>7a. Clean the faulty sensor. 7b. Recalibrate 7c. Test the sensor with the PORTAPROBE™. 7d. Test the electronics with the PORTAPROBE™.</p>

9



9.1 PARTS, ACCESSORIES AND UPGRADES

PPMGEL1B	Free Cl Gel
PPMGEL1C	Electrolyte for Active chlorine (PPMAC010) Thin in clear bottle
PPMGEL2C	Electrolyte for Chlorine Dioxide (PPMCD010)
PPMGEL1H	Electrolyte for Free chlorine high temp (PPMFC00H)
PPMGELPA	Electrolyte for peracetic acid (PPMPA200)
ORP	ORP SENSOR with 10-ft (3-m) shielded cable and BNC connector.
pH	pH SENSOR with 10-ft (3-m) shielded cable and BNC connector.
PPM002	0-2 PPM Chlorine Sensor with connector
PPMAC010	10 PPM Active Chlorine Sensor
PPMTC010	10 PPM Total Chlorine Sensor
PPMFC002S	0-2 PPM Free Chlorine Salt Sensor
PPMFC010S	0-10 PPM Free Chlorine Salt Sensor
PPMBM010	10 PPM Free Br Sensor
PPMCD0100	10 PPM Cl Dioxide Sensor
PPMCEL1C	Clear Flow Cell
PPMM01	Membrane for PPM002/PPM010 Sensors
PPMM02	Membrane for PPM200
PPMMEM10	Total Cl Orange Membrane
PPMMEM1C	Active Cl Clear Membrane
PPMMEM1B	Free Cl Blue Membrane
TEMP	TEMPERATURE SENSOR, 1/4" MPT, 10-ft (3-m) cable



T/C	TEMPERATURE + CONDUCTIVITY SENSOR with 10-ft (3m) cable.
PWFS	ROTARY SAFETY FLOW SWITCH, 1/2" FPT, for bypass line.
MB2100	MOTHERBOARD, electronic PC board for PC2100, 3000 with microprocessor.
MB604	MOTHERBOARD, electronic PC board for PC 5000, 5100, 6000, 7000 with microprocessor.
PB2100	POWER BOARD, electronic PC board for PC2100 with relays (specify).
4-20 mA Board	COMMUNICATIONS BOARD for 4-20 mA input or output (specify), 5 channels.
PPM Board	PC Board for Free Chlorine sensor.
BPL	BYPASS LINE ASSEMBLY, 1/2-in, flow meter, safety flow switch, three (3) ball valves ...
SC	SENSOR CELL, 3 1/2-inch PVC cell, clear cover, two (2) 1/2-inch compression fittings,
FCA	FLOW CELL ASSEMBLY, PVC sensor cell, two (2) 1/2-inch compression fittings, sampling tap, two (2) 1/2-inch ball valves.
SCC	SENSOR CELL CABINET with Flow Cell Assembly.
205T	PVC SOLENOID VALVE for erosion feeder, 1" or 3/4" FPT (specify 24 V or 110VAC).
REM3:	UPGRADE for remote operation with true duplex CHEMCOMM™ Remote Operation
RS485	for direct computer operation with communication converter and true duplex CHEMCOMM™ <i>Windows</i> software
S45M3-V	MULTIPOINT SOLENOID VALVE, 3-way, 3-position motorized ball valve, PVC body, 2" FPT, 110 VAC, 150 psi for electrically operated filter backwash.



8221G2	SOLENOID VALVE, 3-way, brass body, 3/8" FPT, Normally Closed (NC), for hydraulically operated filter backwash.
8262G208	SOLENOID VALVE, brass body, 1/4" FPT, Normally Open (NO), for pneumatically operated filter backwash..



10 Additional References

10.1 Crypto

Recent CDC research presented at the 2015 World Aquatic Health Conference demonstrates that, even at CYA levels as low as 10- to 20 ppm under hyperchlorinated conditions, the current recommended remediation protocol is not adequate to inactivate the necessary 99.9 percent of crypto in pool water. It also concludes that additional methods and secondary sanitation systems to protect swimmers from fecal accidents are desired.

References:

- Anderson, J. R., "A Study of the Influence of Cyanuric Acid on the Bactericidal Effectiveness of Chlorine", Amer. Journal of Pub. Health, Oct, 1965
- Andersen, J. R., "The influence of cyanuric acid on the bactericidal effectiveness of chlorine," Ph.D. Dissertation, University of Wisconsin, 1963.
- Canelli, E., "Chemical, Bacteriological, and Toxicological Properties of Cyanuric Acid and Chlorinated Isocyanurates as Applied to Swimming Pool Disinfection", Department of Chem., University of Naples, American Journal of Public Health, February, 1974
- Fitzgerald, G. P., DerVartanian, M. E., "Pseudomonas aeruginosa for the Evaluation of Swimming Pool Chlorination and Algicides", Water Chemistry Laboratory, Applied Microbiology, University of Wisconsin, Madison; March, 1969
- Hill, V., "Effect of Cyanuric Acid on the Inactivation of Cryptosporidium Parvum Under Hyperchlorination Conditions." World Aquatic Health Conference. Scottsdale, AZ. Oct, 2015
- Johnson, J. D., Disinfection, "Water & Wastewater", University of North Carolina, Chapel Hill, N.C.
- Shields JM, Arrowood MJ, Hill VR, Beach MJ. The effect of cyanuric acid on the chlorine inactivation of Cryptosporidium parvum in 20 ppm free chlorine. J Water Health. 2009;7(1):109-14.
- Williams, K., "CYA, Benefactor or Bomb." Newcastle, CA., Dec, 1997

